



# Light is motion

## Light range 2022

Global No.1 in Automotive Lighting

Light is OSRAM

**OSRAM**

# Quite simply the best solution

OSRAM provides the perfect vehicle lamp for every use and every requirement, be it in cars, motorcycles, trucks or off-road, be it LED, xenon or halogen, and whether for performance or design-oriented drivers.

Category	Page
OSRAM Trust Program	04
Global No.1 in Automotive Lighting	06
Change lamps in pairs	07
LED portfolio overview	08
Xenon portfolio overview	14
Halogen portfolio overview	16
Off-road portfolio overview	21
<b>LED lamps</b>	
■ NIGHT BREAKER® LED for dedicated countries only	23
■ LEDriving® HL <sup>2)</sup>	26
■ LEDriving® FL <sup>2)</sup>	28
■ LEDriving® SL <sup>2)</sup>	30
■ LEDriving® HLM <sup>2)</sup>	32
■ LEDriving® HLT 24V <sup>2)</sup>	34
■ LEDriving® Accessories	36
<b>Xenon</b>	
■ XENARC® NIGHT BREAKER® LASER	39
■ XENARC® COOL BLUE® INTENSE	40
■ XENARC® ULTRA LIFE	41
■ XENARC® ORIGINAL	42
<b>Halogen car</b>	
■ NIGHT BREAKER® 200	45
■ NIGHT BREAKER® LASER	46
■ NIGHT BREAKER® SILVER	47
■ COOL BLUE® INTENSE	48
■ DIADEM® CHROME	49
■ ULTRA LIFE	50
■ ORIGINAL LINE 12 V	52
■ MINIBOX	55
<b>Halogen truck</b>	
■ TRUCKSTAR® PRO	57
■ ORIGINAL LINE 24 V	58
■ Spare lamp kit 24V	60
<b>Halogen motorcycle</b>	
■ ORIGINAL	62
<b>Off-road</b>	
■ SUPER BRIGHT PREMIUM <sup>2)</sup>	
■ SUPER BRIGHT <sup>2)</sup>	64
■ XENARC® COOL BLUE® BOOST <sup>2)</sup>	
■ COOL BLUE® BOOST <sup>2)</sup>	66

Category	Page
<b>LED fixtures</b>	
■ LEDriving® headlights	70
■ LEDriving® XENARC® headlights	74
■ LEDriving® dynamic mirror indicator	76
■ LEDriving® tail lights	80
■ LEDriving® driving lights	82
■ LEDriving® working lights	86
■ LEDriving® daytime running lights	88
■ LEDambient® <sup>2)</sup>	90
<b>LED accessories</b>	
■ LEDinspect®	94
■ LEDguardian® warning lights <sup>3)</sup>	102
■ ONYX COPILOT®	106
<b>Tools</b>	
Automotive lamp cabinet, Shelf Rack, MINIWATT® assortment box	108
Measurements	110
Bases	118
Index	120
<b>Summary of types and applications</b>	134
Order information	142

■ = INNOVATION ■ = PERFORMANCE ■ = DESIGN ■ = COMFORT ■ = ORIGINAL

- 1) Please note: This catalogue contains an international portfolio. Several countries do not allow sale and use of non-ECE approved products. Please contact your local distributor for information on the availability in your country.
- 2) These products do not have ECE approval and must not be used on public roads in any exterior application. Public roads use leads to cancellation of operating license and loss of insurance coverage. Several countries forbid sale and use of these products. Please contact your local distributor for further information.
- 3) Not approved as warning light according to German Road Traffic Licensing Regulations (StVZO). Not for sale in Germany.

All OSRAM 12 V and 24 V halogen automotive lamps are UV-reduced, can replace existing lamps and meet the relevant standards, e.g. ECE R37 (with the exception of OFF-ROAD lamps)



## The OSRAM Trust Program

Verify genuine lamps. Ensure OSRAM quality.

Works for all xenon lamps and also for halogen lamps in DUO BOXES. As the leading manufacturer of automotive lighting, OSRAM is synonymous with quality and high-performance products. Unfortunately, more and more counterfeit lamps are making their way into the market, undermining confidence and posing a threat to safety. These sometimes indistinguishable fakes can be both expensive and dangerous to you and others.

### Fake lamps can cause real danger

#### The risks

Installing counterfeit lamps in a vehicle can have serious consequences. These products may not only impact the safety of road users but can also damage parts of the car or motorcycle.

- **Shorter lifetime**  
leads to unexpected failure
- **Poor light performance**  
results in low visibility
- **Overheating**  
causes damage to headlights





# The OSRAM advantage

## Tried and trusted automotive lighting.

### Safety

- High brightness for improved road visibility
- Greater visibility for oncoming traffic

### Quality

- Maintain integrity of headlights
- Does not hamper electronic components (control units, airbags, communication systems, etc.)
- Longer lifespan of high-quality products

### Compliance

- Manufactured according to all requirements of the ECE standard
- Approved for use on roads

### Sustainability

- Buying genuine lamps helps reputable manufacturers maintain quality levels and develop new technology
- Reducing demand discourages production of dangerous fakes

## How to check your lamps

### Two steps to certainty

As part of the OSRAM Trust Program, we have implemented two safety features into the manufacturing process. You can use these features to verify your lamp(s) in just a few seconds on our online checking tool.

### Online checking tool

Visit [osram.com/trust](https://osram.com/trust) or scan the QR code on your product using a smartphone or tablet device, and take the following steps:

**1** Enter the **7-digit label code** which can be found on every genuine OSRAM xenon and halogen DUO BOX packing. This will be auto-filled when using the QR code on the label.



**2** Next, you will be asked whether the automatically prompted lamp data matches either the **unique lamp code**, on the base of your xenon lamps OR **the product family and OSRAM order no** on your halogen DUO BOX.



### The moment of truth

Please decide whether the data matches or not. Use either the “Yes” or “No” button on the page. After doing so, you’ll receive one of three possible outcomes.

#### Yes → Genuine

Packaging is authenticated and lamp data is correct.

→ You have purchased original OSRAM lamps

#### Possible issues

Packaging is authenticated but the label code has been entered too often.

→ Contact OSRAM customer service via [trust-com@osram.com](mailto:trust-com@osram.com)

#### No → No match

Invalid label code or the prompted lamp data doesn’t match with your product(s).

→ Contact your dealer or OSRAM customer service

# 200 best reasons for OSRAM – the number 1 worldwide

On average, around 200 lamps are fitted in every car – that’s 200 times top quality from OSRAM, the global leader in lighting solutions on and in your vehicle. OSRAM is a leader in innovation and technology, and sells the highest volume of lamps in the fast growing OEM market for cars, as well as in the rapidly expanding market for replacement lamps.

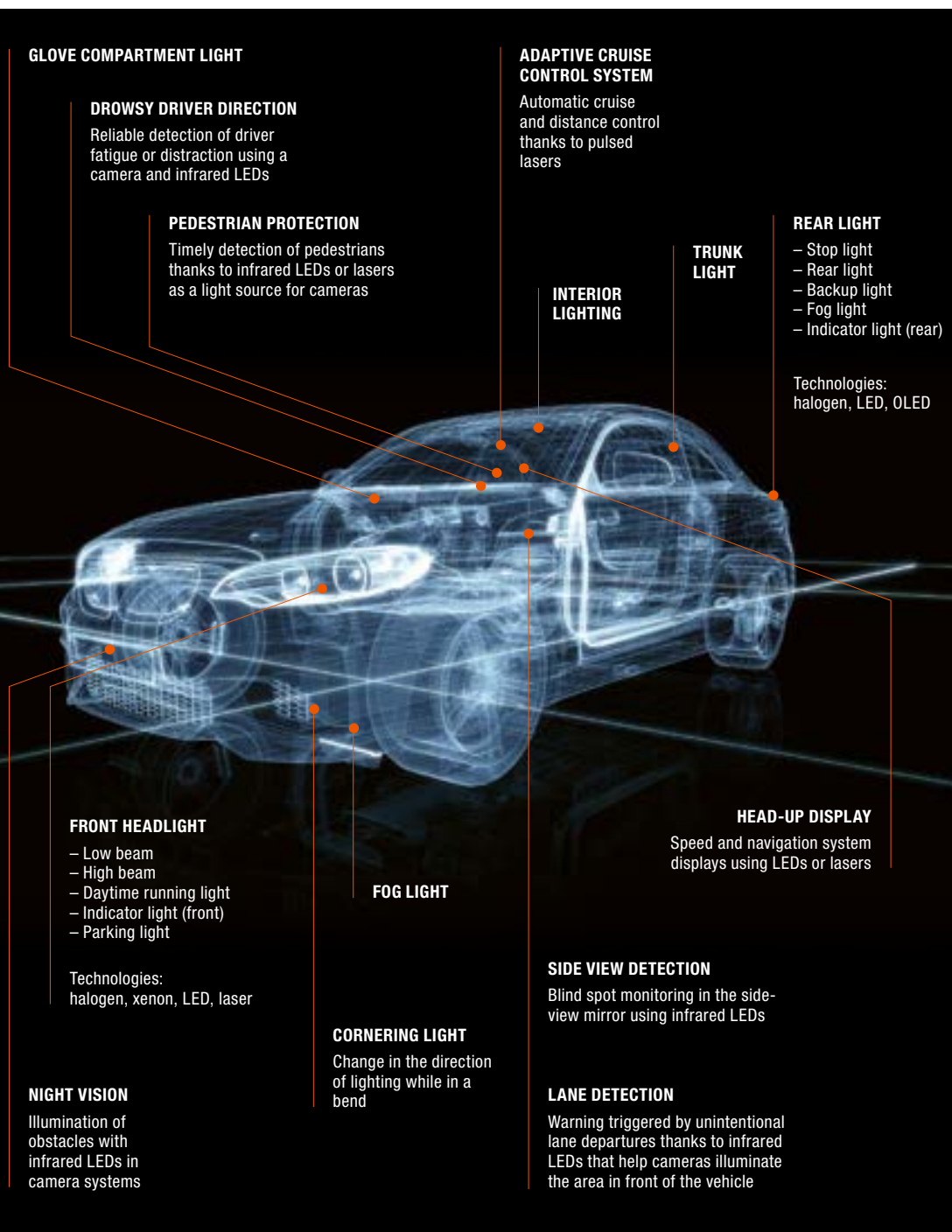

## From the headlights to the rear lights

No matter where you look in a car, you will find lights. Their possible applications are immense. Several examples show the many different ways that OSRAM products manufactured across the world are used.

Here you can see the wide range of possible applications of lights in cars.

Greater Performance, enhanced safety and a modern design are the trends for modern vehicle lighting – and also the focus of our research.

Are you passionate about your car service?



Yes

No

OK, maybe this job isn't for you.



How do you feel about mullets?

I could pull it off.

Love the confidence. Let's talk about sports.



Are you a football fan?

Great! Staying up to date isn't just good for your style. It's smart business too.

Please, don't remind me. Cringe!

Unlike an 80's haircut, your service offering is looking good.

Be innovative - Impress customers with the latest car light upgrades.

Ole, ole ...

Not so much.



So cars are your one true passion?



Did your team win their last game?

\*silent sobbing

Oh, yes!

I like to go fast, what can I say.

Unlike your favourite sports team, you won't let your customers down.

Be proactive - Check & change customers' car lights before they break so everybody wins.

And the game before that?

\*deathly stare

Just like rally drivers, car lights always come in pairs.

Be smart - Change car lights in pairs to help keep your customers safe.

The choices you make say a lot about the things you care about most. Show your customers that you really care about their sight and safety.

Use our **three Facts of Light** to help them choose the right high-quality OEM and upgrade automotive light. And remember, if it's not bright, it's not right. Find out more [osram.de/notbright-notright](http://osram.de/notbright-notright)



# Portfolio overview LED



>> Page 23

INNOVATION / LED RETROFITS

## NIGHT BREAKER® LED<sup>1)</sup>



### Street legal LED lamp

NIGHT BREAKER® LED is the first LED retrofit for low beam and high beam that is approved in Germany. Approvals for further countries are ongoing. The plug-and-play solution offers drivers significant advantages: very high cool white color temperature of 6,000 Kelvin with up to 230% more brightness compared to the minimum requirements of ECE R112, up to 5 times longer lifespan compared to halogen lamps and an additional 50% less glare.

### Range

P43t (H4), PX26d (H7)



>> Page 26

INNOVATION / LED RETROFITS

## LEDriving® HL<sup>2)</sup> LED high and low beam lamp



### Light in a new dimension

The OSRAM LED high and low beam lamps represent the most convenient solution in order to upgrade your existing headlights – providing a stylish cool white look with 6,000 K as well as improved visibility for everything that lies ahead of you.

### Range

P14.5s (H1), P43t (H4), PX26d (H7), PGJ19-2 (H11), P22d (HB4)



>> Page 28

INNOVATION / LED RETROFITS

## LEDriving® FL<sup>2)</sup> LED fog lamp



### Light is maximum visibility

The new LEDriving® FL as socket solution provides an upgrade for conventional fog lamps with LED technology and a color temperature of 6,000 K. These LED fog lamps perfectly match existing LED daytime running lights and xenon low- and high-beam systems.

### Range

PGJ19 (H8/H11/H16), PY20d (H10), PG20-7 (PSX24W)

1) Approved LED headlamp. Only applies to the respective countries in which there is approval and the vehicle models and light functions currently listed in the compatibility list. For exact conditions see [www.osram.com/nb-led](http://www.osram.com/nb-led)



>> Page 30

INNOVATION / LED RETROFITS

### LEDriving® SL<sup>2)</sup> LED interior and exterior signal lamps



#### Wide range of different bases and different light colors

Perfect for a multitude of applications, OSRAM LED signal lamps LEDDriving® SL illuminate vehicle exteriors and interiors with high color temperatures of up to 6,000 K – simply replace old lamps with OSRAM's LED plug-and-play solution.

#### Range

PG18.5d-1 (P13W), PG20-1 (PS19W), W2.1x9.5d (W5W/WY5W, W16W), SV8.5-8 (Festoon 31 mm, C5W 36 mm, Festoon 41 mm), BA15s (P21W, R5W, R10W), BAU15s (PY21W), W3x16q (W21/5W), W3x16d (W21W), WX3x16d (WY21W), BAY15d (P21/5W), W2.5x16q (P27/7W), BA9s (T4W), W2x4.6d (W2.3W)



>> Page 32

INNOVATION / LED RETROFITS

### LEDriving® HLM<sup>2)</sup> LED high and low beam lamp motorcycle



#### Easy upgrade from conventional motorcycle headlights to cool white LED light

The OSRAM LEDDriving® HLM represent an easy solution to upgrade conventional motorcycle headlights with cool white LED light – with a color temperature of 6,000 K, they provide a stylish and modern look as well as superior brightness.

#### Range

PX43t (HS1), P15d-25-1 (T19)

2) These products do not have ECE approval and must not be used on public roads in any exterior application. Public roads use leads to cancellation of operating license and loss of insurance coverage. Several countries forbid sale and use of these products. Please contact your local distributor for further information.





>> Page 34

INNOVATION / LED RETROFITS

**LEDDriving® HLT<sup>1)</sup> 24 V**  
**LED high and low beam lamp**  
**truck**



**Highly energy-efficient bright LED light**

Simply replace old truck lamps with OSRAM's LED replacement lamps for forward lighting to benefit from highly energy-efficient bright LED light. LEDDriving® HLT for high and low beam applications are 24 V compatible and stand out with very high brightness, high compatibility, easy installation and no radio disturbance.

**Range**

P14.5s (H1), P43t (H4), PX26d (H7)



>> Page 70/74/80

INNOVATION / LED FIXTURES

**LEDDriving® headlight<sup>2)</sup>**  
**LEDDriving® XENARC® headlight<sup>2)</sup>**  
**LEDDriving® tail light<sup>2)</sup>**



**High efficiency meets extreme effectiveness**

The OSRAM LEDDriving® headlights & tail lights offer high efficiency in combination with extreme effectiveness to impressively complement the individual look of your vehicle. These headlights & tail lights bring precise lighting technology to the front and the rear of your vehicle and onto the road.

**Range**

LEDHL102, LEDHL103, LEDHL104, LEDHL105, LEDHL107, LEDHL108, LEDHL109, LEDTL101, LEDTL102



>> Page 76

INNOVATION / LED FIXTURES

**LEDDriving® dynamic mirror indicator<sup>2)</sup>**



**Individual design meets innovative lighting technology**

The OSRAM LEDDriving® dynamic mirror indicators offer individual design in combination with innovative lighting technology to impressively complement the unique look of your vehicle. The OSRAM LEDDriving® dynamic mirror indicators bring precise lighting technology to the side of your vehicle and onto the road.

**Range**

LEDDMI 5G0, LEDDMI 5K0, LEDDMI 3G0, LEDDMI F20, LEDDMI 8W0, LEDDMI 5F0, LEDDMI 8V0

1) These products do not have ECE approval and must not be used on public roads in any exterior application. Public roads use leads to cancellation of operating license and loss of insurance coverage. Several countries forbid sale and use of these products. Please contact your local distributor for further information.



>> Page 82

INNOVATION / LED FIXTURES

LEDriving® driving lights<sup>3)</sup>



**Powerful performance and versatile applications**

If the road and the surroundings are to be illuminated more intensively, the LEDriving® driving lights facing this challenge with ease. Thanks to a variety of designs, shapes & light profiles, they convince with intense white LED light, at work & in the spare time, on dark country roads & forest paths, on-road & off-road.

**Range**

AX-, FX-, MX-, SX-, VX-SERIES



>> Page 86

INNOVATION / LED FIXTURES

LEDriving® working lights<sup>1)</sup>



**Professional light for professional work**

If the working environment and the surroundings are to be illuminated more intensively, the LEDriving® working lights facing this challenge with ease. Thanks to a variety of designs, shapes & light profiles, they convince with intense white LED light, at work, on construction sites, agricultural activities, in forest operations & off-road tracks.

**Range**

MX-, VX-SERIES



>> Page 88

INNOVATION / LED FIXTURES

LEDriving® daytime running lights



**Stylish highlights for state-of-the-art headlights**

Innovative, easy-to-install light-guide and pixel solution with high-quality LED technology for low energy consumption and long lifetime: LEDriving® daytime running lights are the right choice for drivers who want to increase visibility during the day and with an eye for design.

**Range**

LG, PX-5

2) Refer to [www.osram.com/am](http://www.osram.com/am) for detailed vehicle models

3) Special mounting regulations apply



>> Page 90

INNOVATION / LED STYLING LIGHTS

LEDambient®



Interior ambient lighting

The LEDambient® interior lights enable you to illuminate every single corner of your car. The high brightness of the products combined with the modern color temperatures puts your car into a new light. The LED strips are rapidly and easily mounted.

Range

TUNING LIGHTS BASE KIT<sup>1)</sup>,  
TUNING LIGHTS EXTENSION KIT<sup>1)</sup>,  
INTERIOR STRIP KIT<sup>1)</sup>



>> Page 94

INNOVATION / LED INSPECTION LIGHTS

LEDinspect®



Light is multifunctional

A comprehensive range of inspection lights, specially designed for maintenance and repair work, for professional and private use, for mechanics, technicians, car enthusiasts and for all those who want to bring more light into the darkness. For a wide range of applications indoor & outdoor, from the basement to the attic, from the garage to the workshop.

Range

MINI 250, MAX 500, SLIM 500, HEADTORCH 250,  
FAST CHARGE PRO 500, FAST CHARGE SLIM 500,  
UTILITY 1000, POCKET 200, POCKET PRO 400, SLIM  
MAX 1000, POCKET-B 200, TWIST 250, MINI COM-  
PACT 80, PROFESSIONAL 180, FLOODER 10W,  
FLOODER 20W, HELICOPTER 1000, SPACESHIP 1000

1) These products do not have ECE approval and must not be used on public roads in any exterior application. Public roads use leads to cancellation of operating license and loss of insurance coverage. Several countries forbid sale and use of these products. Please contact your local distributor for further information.



>> Page 102

#### INNOVATION / LED WARNING LIGHTS

##### LEDguardian® & LIGHTsignal



##### See and be seen with OSRAM

Light is safety. OSRAM LEDguardian® warning lights are the ideal accessory for car and truck drivers who want to be prepared for almost any situation.

##### Range

SAVER LIGHT PLUS<sup>3)</sup>, TRUCK FLARE SIGNAL TA 19<sup>2)</sup>, ROAD FLARE<sup>3)</sup>, ROAD FLARE SIGNAL V16<sup>3)</sup>, LIGHTsignal LED, LIGHTsignal HAL



>> Page 106

#### INNOVATION / LED READING LIGHTS

##### ONYX COPILOT®



##### Good light for a good ride

ONYX COPILOT® is a flexible LED reading light with pleasantly warm, glare-free light. With its high flexibility, the ONYX COPILOT® light has a wide range of options for illuminating specific areas of the vehicle interior.

##### Range

ONYX-USB, ONYX M+7, ONYX L+7

2) Approved as warning light according to German Road Traffic Licensing Regulations (StVZO) §53a, §22a TA19 StVZO

3) Not approved as warning light according to German Road Traffic Licensing Regulations (StVZO). Not for sale in Germany.



# Portfolio overview xenon



>> Page 39

## PERFORMANCE

XENARC® NIGHT BREAKER® LASER  
**UP TO +200% BRIGHTNESS<sup>1)</sup>**

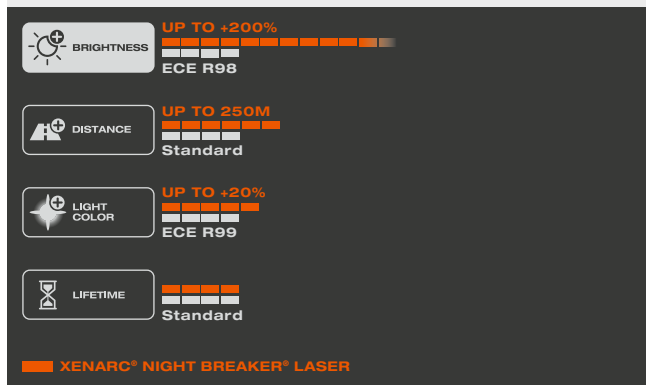

**ECE/Range**  
 D1S, D2S, D3S, D4S



>> Page 40

## DESIGN

XENARC® COOL BLUE® INTENSE  
**LED WHITE LIGHT**

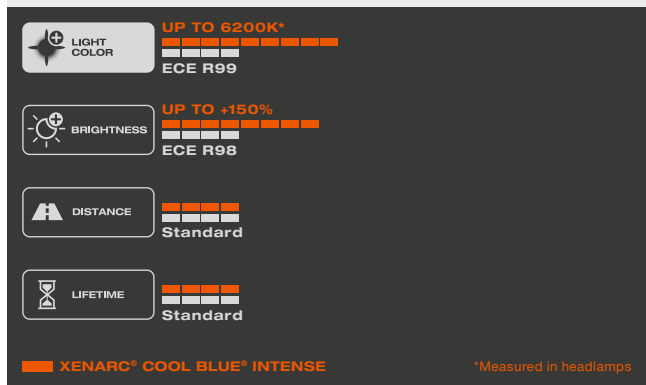

**ECE/Range**  
 D1S, D2S, D2R, D3S, D4S, D8S

\*Measured in headlamps

1) Compared to minimum ECE R98 requirements





>> Page 41

COMFORT

XENARC® ULTRA LIFE

**10-YEAR OSRAM  
GUARANTEE<sup>2)</sup>**

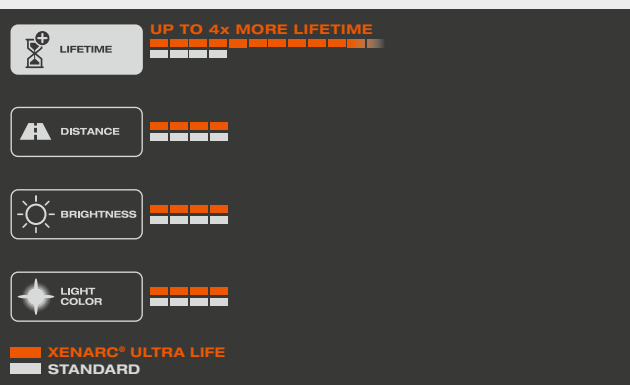

**ECE/Range**

D1S, D2S, D3S, D4S



>> Page 42

ORIGINAL

XENARC® ORIGINAL

**ORIGINAL SPARE PART**

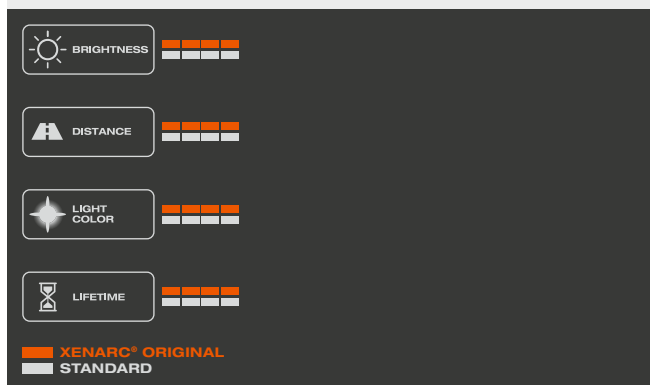

**ECE/Range**

D1S, D1R, D2S, D2R, D3S, D3R, D4S, D4R, D5S, D8S

2) With online product registration. Refer to [www.osram.com/am-guarantee](http://www.osram.com/am-guarantee) for precise conditions and registration

# Portfolio overview halogen car



>> Page 45

**PERFORMANCE**

**NIGHT BREAKER® 200**

**UP TO +200%  
BRIGHTNESS<sup>1)</sup>**

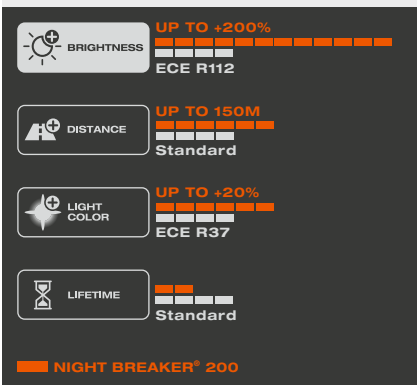

**ECE/Range**  
H4, H7



>> Page 46

**PERFORMANCE**

**NIGHT BREAKER® LASER**

**UP TO +150%  
BRIGHTNESS<sup>1)</sup>**

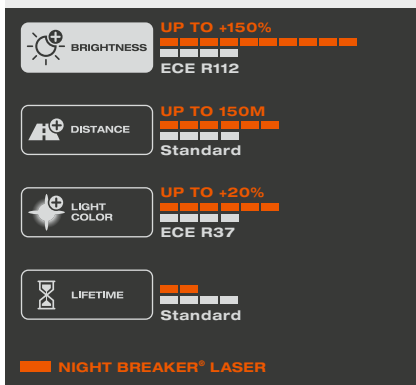

**ECE/Range**  
H1, H3, H4, H7, H8, H11, HB3, HB4



>> Page 47

**PERFORMANCE**

**NIGHT BREAKER® SILVER**

**UP TO +100%  
BRIGHTNESS<sup>1)</sup>**

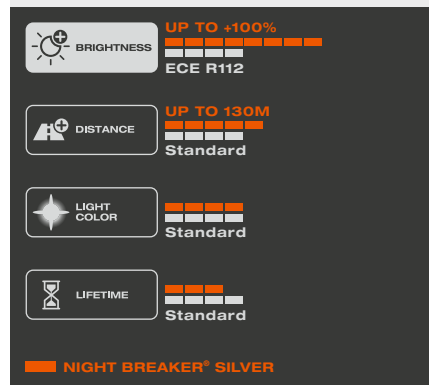

**ECE/Range**  
H1, H4, H7, H11

1) Compared to minimum ECE R112 requirements



>> Page 48

DESIGN

COOL BLUE® INTENSE  
**LED LOOK**

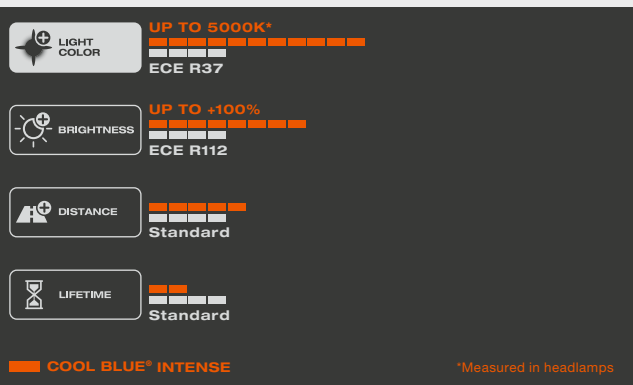

**ECE/Range**  
H1, H4, H7, H8, H11, H15, HB3, HB4, HIR2, W5W



>> Page 49

DESIGN

DIADEM® CHROME  
**AMBER WHEN ON**

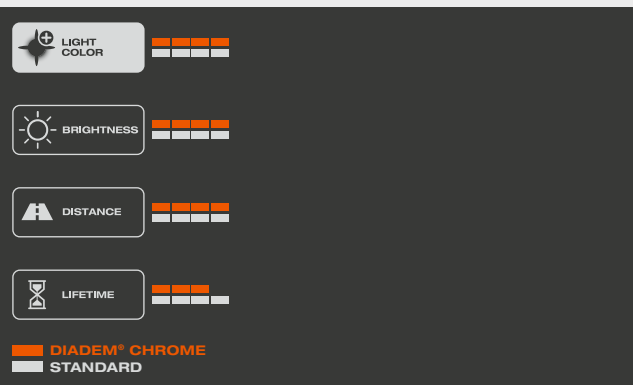

**ECE/Range**  
WY5W, PY21W



>> Page 50

COMFORT

ULTRA LIFE

**4-YEAR OSRAM GUARANTEE<sup>2)</sup>**

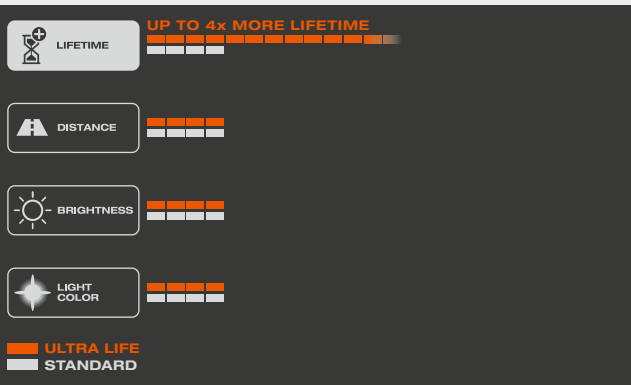

**ECE/Range**

H1, H4, H7, H11, P21W, PY21W, P21/5W, W5W, R5W, R10W, C5W, H6W, HY21W



>> Page 52

ORIGINAL

ORIGINAL

**ORIGINAL SPARE PART**

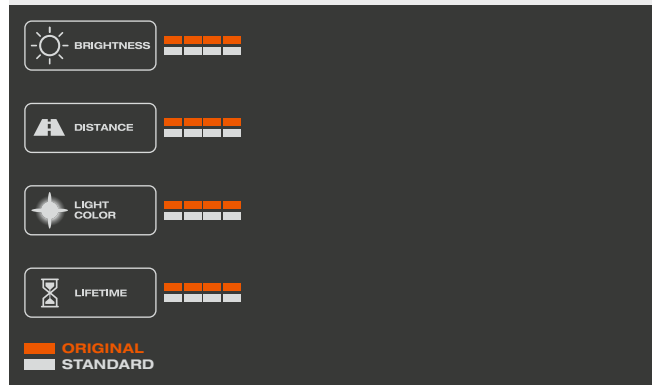

**ECE/Range**

Complete Product Range

2) 4th year with online product registration. Refer to [www.osram.com/am-guarantee](http://www.osram.com/am-guarantee) for precise conditions and registration

# Portfolio overview halogen truck



>> Page 57

## PERFORMANCE

TRUCKSTAR® PRO

**UP TO +120% BRIGHTNESS<sup>1)</sup>**

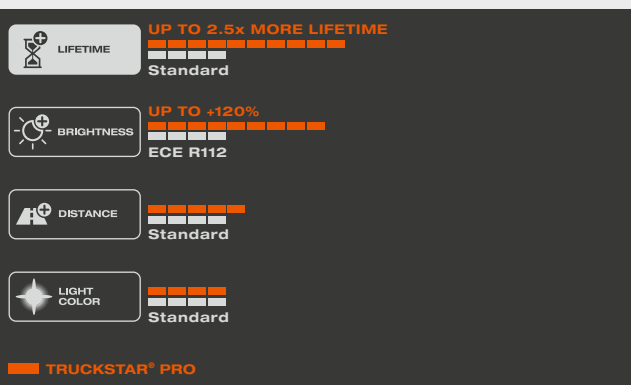

### ECE/Range

H1, H3, H4, H7, H11, PY21W, P21W, P21/5W, W5W, R5W, R10W, T4W



>> Page 58

## ORIGINAL

ORIGINAL

**ORIGINAL SPARE PART**

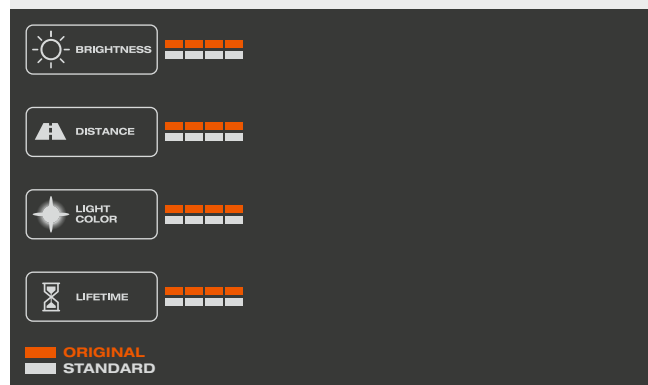

### ECE/Range

Complete Product Range



# Portfolio overview motorcycle & off-road



>> Page 62

## ORIGINAL

ORIGINAL

### ORIGINAL SPARE PART

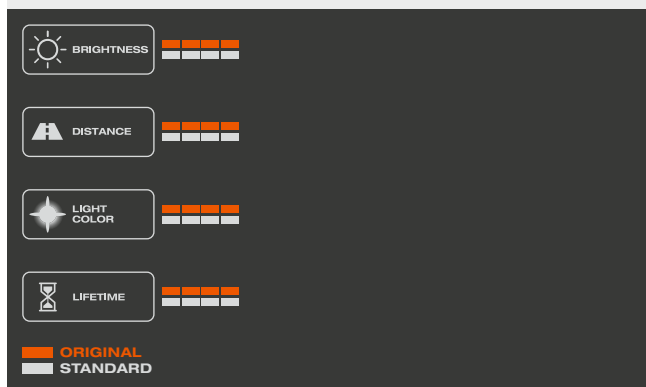

#### ECE/Range

S1, S2, HS1



>> Page 65

## PERFORMANCE

SUPER BRIGHT/SUPER BRIGHT PREMIUM<sup>1)</sup>

### EXTRA POWER

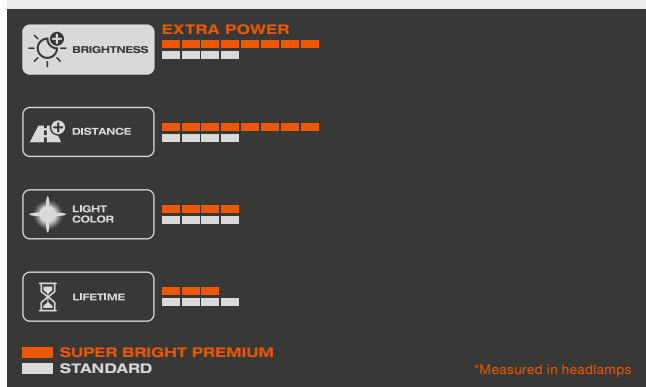

#### ECE/Range

P14.5s (H1), PK22s (H3), P43t (H4), PX26d (H7), P20d (HB3), P22d (HB4), PX14.5s, PKY22s, P45t (R2)



>> Page 66



>> Page 66

DESIGN

XENARC® COOL BLUE® BOOST<sup>1)</sup>

LED HYPER WHITE



DESIGN

COOL BLUE® BOOST<sup>1)</sup>

LED HYPER LOOK

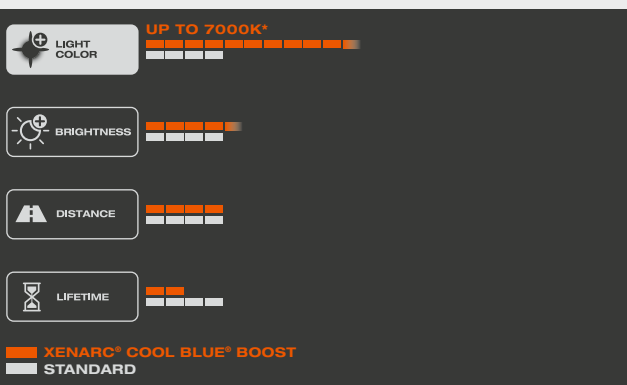

ECE/Range

PK32d-2 (D1S), P32d-2 (D2S), PK32d-5 (D3S), P32d-5 (D4S)



ECE/Range

P14.5s (H1), P43t (H4), PX26d (H7), PGJ19-2 (H11)

\*Measured in headlamps

1) These products do not have ECE approval and must not be used on public roads in any exterior application. Public roads use leads to cancellation of operating license and loss of insurance coverage. Several countries forbid sale and use of these products. Please contact your local distributor for further information.



## LEDDriving<sup>®</sup> replacement lamps

OSRAM provides a wide range of LED replacement lamps for various applications. The LEDDriving<sup>®</sup> RETROFIT portfolio includes LED high and low beam lamps, fog lamps, signal as well as interior lamps with superior brightness and color temperatures of up to 6,000 K.



# NIGHT BREAKER® LED

## First OSRAM street legal LED in low and high beam application for dedicated countries

NIGHT BREAKER® LED will be the first LED retrofit for low and high beam that is approved in dedicated countries. The plug-and-play solution offers drivers significant advantages: very high cool white color temperature of 6,000 Kelvin with up to 230% more brightness compared to the minimum requirements of ECE R112, up to 5 times longer lifespan compared to halogen lamps and an additional 50% less glare.

### Features

- First street legal LED in low and high beam application in Germany and upcoming for further countries<sup>1)</sup>
- Up to 230% more brightness<sup>2)</sup>
- Up to 5 times more lifetime and dedicated guarantee<sup>3)</sup>
- Premium quality developed and produced in certified OSRAM production plant in Italy
- Compact design, individual car testing approved by official inspection authorities

### Benefits

- Better seen and be seen, for more safety on the road, especially at night
- Cool White LED-Upgrade with color temperature close to daylight for specific car models
- Environmentally friendly through longer durability and less garage shop visits and reduced energy<sup>4)</sup>
- Latest LED technology as solution for used cars with counterfeit protection thanks to OSRAM Trust program
- Easy installation with suitable accessories for installation and an affordable alternative compared to full LED systems

### OSRAM LED Street Legal product range

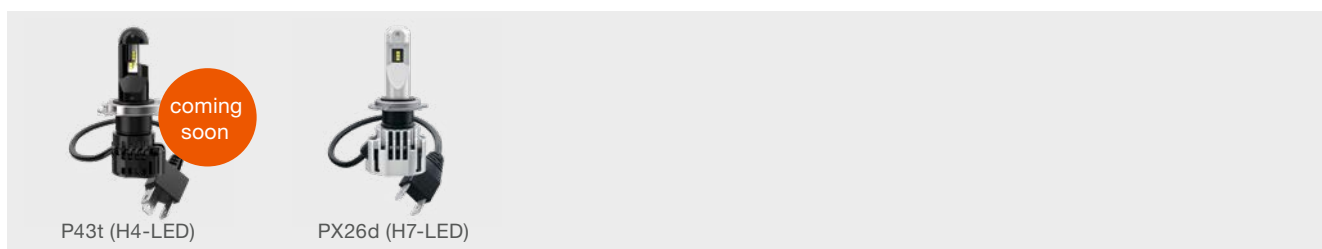

Product Reference		Product Number	V	W	K	COLOR			
64193DWNB	P43t (H4)	4062172 <b>284691</b>	12	23/27	6000	Cool White	2	4	1 <sup>P.110</sup>
64193DWNB-FB	P43t (H4)	4062172 <b>284714</b>	12	23/27	6000	Cool White	1	2	1 <sup>P.110</sup>
64210DWNB	PX26d (H7)	4062172 <b>155045</b>	12	19	6000	Cool White	2	4	2 <sup>P.110</sup>
64210DWNB-FB	PX26d (H7)	4062172 <b>254779</b>	12	19	6000	Cool White	1	2	2 <sup>P.110</sup>

1) Approved LED headlamp. Only applies to the respective countries in which there is approval and the vehicle models and light functions currently listed in the compatibility list. For exact conditions see [www.osram.com/nb-led](http://www.osram.com/nb-led) | 2) Compared to minimum ECE R112. On top with 50% less glare. | 3) Refer to [www.osram.com/am-guarantee](http://www.osram.com/am-guarantee) for precise conditions| 4) Compared to halogen lamps

coming soon



The **LEDDriving® SMART CANBUS** serves as a bypass of a vehicle's lamp failure detection system when using a H7-LED retrofit lamp. The control unit offers an easy installation and is suitable for most vehicle models with automatic lamp failure detection system. One additional feature is the flickering-free in the vehicle's headlamp. OSRAM provides a 3 year guarantee for this product. For precise conditions refer to [www.osram.com/am-guarantee](http://www.osram.com/am-guarantee).

**Features**

- Error-free
- Flicker-free
- 3-year OSRAM guarantee<sup>1)</sup>

**Benefits**

- Prevent error messages in bord computers prompted by H7-LED lamps
- OSRAM quality for more customer satisfaction
- Suitable for most vehicle models with automatic lamp failure detection system

**OSRAM LED H7 SMART CANBUS product range<sup>2)</sup>**



Product Reference		Product Number	V	W	K	COLOR			No.
LEDSC01-2HFB		4062172176439	12	12	-	-	2	4	-
LEDSC02-1-2HFB		4062172176460	12	16	-	-	2	4	-
LEDSC03-2HFB		4062172176491	12	12	-	-	2	4	-
LEDSC03-1-2HFB		4062172278249	12	12	-	-	2	4	-

**LEDDriving® CAP** are designed to enable the installation of the H7-LED to have an accurate fit and to protect the headlight system. These products are a replacement of the original cap to offer a qualitative system component for the legal usage.

**Features**

- Enables the installation of the H7-LED
- Replacement of original cap in OSRAM quality

**Benefits**

- Mechanical fit and protects headlight system
- System component for H7-LED installation

**OSRAM LED H7 CAP product range**



Product Reference		Product Number	V	W	K	COLOR			No.
LEDCAP01		4062172241878	-	-	-	-	2	8	-
LEDCAP02		4062172241908	-	-	-	-	2	8	-
LEDCAP03		4062172271394	-	-	-	-	2	8	-
LEDCAP04		4062172278560	-	-	-	-	2	8	-





The mounting brackets offer an easy installation and compatibility for a variety of cars. Compatibility can be checked on the OSRAM website. Only the combination of OSRAM NIGHT BREAKER® LED lamps in connection with the official OSRAM accessories – **LEDDriving® ADAPTER** and LEDDriving® SMART CANBUS (where required) - is permitted.

**Features**

- Fits for H7-LED
- Fixes H7-LED
- Improves the setting of the LED headlamp

**Benefits**

- Suitable for various vehicle models
- Easy installation for a precise light distribution
- Reduced glare for oncoming traffic

**OSRAM LED H7 ADAPTER product range**



Product Reference	Product Number	V	W	K	COLOR			No.
64210DA01	4062172160384	-	-	-	-	2	20	-
64210DA01-1	4062172206532	-	-	-	-	2	20	-
64210DA02	4062172160414	-	-	-	-	2	20	-
64210DA03-1	4062172201872	-	-	-	-	2	20	-
64210DA04	4062172175029	-	-	-	-	2	20	-
64210DA05	4062172233170	-	-	-	-	2	20	-
64210DA07	4062172233835	-	-	-	-	2	20	-
64210DA08	4062172242745	-	-	-	-	2	20	-

1) Refer to [www.osram.com/am-guarantee](http://www.osram.com/am-guarantee) for precise conditions

2) LEDDriving® SMART CANBUS (P.37) avoids error messages on the bord computer when using LED lamps



# OSRAM LEDriving® HL

## LED high and low beam in a new dimension

With a color temperature of 6,000 K and a very compact design, the OSRAM LEDriving® HL retrofits provide an easy solution to upgrade car headlights with cool white LED light – providing a stylish look as well as superior brightness. The LED high and low beam lamps by OSRAM as replacement of conventional H1, H4, H7, HB4 and H11 lamps. With the latest LED technology and very compact design, these new lamps allow a high compatibility and an easy installation for an even wider range of car models. LEDriving® HL lamps are 12 V compatible. The pair of lamps comes with a 5-year OSRAM guarantee<sup>1)</sup> and with a long service life.



### Features<sup>2)</sup>

- Cool White color temperature of 6,000 K
- Superior brightness
- Very compact LED replacement for conventional H1, H4, H7, HB4 and H11 high and low beam lamps
- Premium OSRAM quality made in Italy
- Long lifetime of up to 5,000 h
- Integrated electronics, no external driver

### Benefits<sup>2)</sup>

- Better visibility thanks to daylight effect
- More light allows to see farther and therefore react sooner. Signs, obstacles and hazards can be recognized sooner
- Reduced glaring thanks to an optimized light distribution
- 5-year guarantee<sup>1)</sup>
- More durability due to LED technology



Conventional halogen lamp

OSRAM LEDriving® HL lamp



**Check the compatibility of your car!**  
[www.osram.com/ledcheck](http://www.osram.com/ledcheck)



**OSRAM LEDDriving® HL product range**



Product Reference		Product Number	V	W	K	COLOR			
64150DWP-02HFB	P14.5s (H1)	4062172 <b>168137</b>	12	12	6000	Cool White	2	8	3 <sup>P.110</sup>
9726CW	P43t (H4)	4052899 <b>605121</b>	12/24	14	6000	Cool White	2	4	4 <sup>P.110</sup>
67210CW <sup>3)</sup>	PX26d (H7)	4052899 <b>605084</b>	12/24	14	6000	Cool White	2	4	5 <sup>P.110</sup>
67211CW <sup>4)</sup>	PGJ19-2 (H11)	4052899 <b>605107</b>	12/24	14	6000	Cool White	2	4	6 <sup>P.110</sup>
9736CW	P22d (HB4)	4052899 <b>605145</b>	12/24	14	6000	Cool White	2	4	7 <sup>P.110</sup>



Conventional lamp – Halogen high beam

OSRAM LEDDriving® HL – LED high beam



Conventional lamp – Halogen low beam

OSRAM LEDDriving® HL – LED low beam

1) Refer to [www.osram.com/am-guarantee](http://www.osram.com/am-guarantee) for precise conditions | 2) These products do not have ECE approval and must not be used on public roads in any exterior application. Public roads use leads to cancellation of operating license and loss of insurance coverage. Several countries forbid sale and use of these products. Please contact your local distributor for further information. | 3) See page 37 for accessoires | 4) LEDDriving® CANBUS CONTROL UNIT (P.37) avoids error messages on the board computer when using LED lamps within 50 W (LEDCBCTRL103) applications



## OSRAM LEDriving<sup>®</sup> FL

### LED fog lamps for maximum visibility

The latest generation of OSRAM LED fog lamps provides an even more convenient solution in order to replace and upgrade existing halogen fog lamps: With its ultra compact dimensions, the OSRAM LEDriving<sup>®</sup> FL provides optimized compatibility as well as easy plug & play installation. Upgrading with state-of-the-art LED technology and a color temperature of 6,000 K for a stylish cool white look as well as improved visibility. These LED products offer a perfect color match with xenon and LED headlights and are for conventional H8/H11/H16 or H10 fog lamps. A pair of new LEDriving<sup>®</sup> FL lamps, comes with a 3-year OSRAM guarantee<sup>1)</sup> as well as with a long service life by less energy consumption.

#### Features<sup>2)</sup>

- Cool White color temperature of 6,000 K
- Superior brightness
- Ultra compact LED replacement for conventional H8/H11/H16 and H10 fog lamps as socket solution
- Premium OSRAM quality

#### Benefits<sup>2)</sup>

- Better visibility in foggy situations with a perfect color match for xenon and LED headlights. Signs, obstacles and hazards can be recognized sooner.
- More light allows to see farther and therefore react sooner with reduced glaring thanks to an optimized light distribution
- Easy installation with optimized compatibility
- 3-year guarantee<sup>1)</sup>



**OSRAM LEDDriving® FL product range**



Product Reference		Product Number	V	W	K	COLOR			No.
67219CW	PGJ19 (H8/H11/H16) <sup>3)</sup>	4052899 <b>605046</b>	12	9	6000	Cool White	2	4	8 <sup>P.110</sup>
9745CW	PY20d (H10)	4052899 <b>605060</b>	12	9	6000	Cool White	2	4	9 <sup>P.110</sup>
2604CW	PG20-7 (PSX24W)	4062172 <b>058360</b>	12	6.7	6000	Cool White	2	4	10 <sup>P.110</sup>



Conventional lamp –  
Halogen fog light

OSRAM LEDDriving® FL –  
LED fog light

- 1) Refer to [www.osram.com/am-guarantee](http://www.osram.com/am-guarantee) for precise conditions
- 2) These products do not have ECE approval and must not be used on public roads in any exterior application. Public roads use leads to cancellation of operating license and loss of insurance coverage. Several countries forbid sale and use of these products. Please contact your local distributor for further information.
- 3) LEDDriving® CANBUS CONTROL UNIT (P.37) avoids error messages on the board computer when using LED lamps within 50 W (LEDCBCTRL103) applications





## OSRAM LEDriving<sup>®</sup> SL

### Wide range of interior and exterior signal lamps

The new OSRAM LEDriving<sup>®</sup> SL portfolio combines premium quality of the latest LED technology for a competitive price. In addition, OSRAM LED replacement lamps offer a modern and intense LED light of up to 6000 Kelvin color temperature. These LED signal lamps replace conventional lamps as easy plug-and-play solution for various vehicle applications. In comparison to standard lamps, LED retrofit lamps have a quicker light up. Meaning faster signals provide more reaction time for drivers behind you. On top OSRAM offers a 4-year guarantee<sup>1)</sup> for these LEDriving<sup>®</sup> SL lamps.

#### Features<sup>2)3)</sup>

- High color temperatures of up to 6,000 K
- High brightness
- Replaces conventional signal lamps for interior and exterior application
- OSRAM quality
- Long lifetime of up to 2,500 h with low energy consumption

#### Benefits<sup>2)3)</sup>

- Multiple light colors for a variety of customization options
- Non-selective illumination thanks to homogeneous light distribution
- Simple installation
- 4-year guarantee<sup>1)</sup>
- Durable and energy-efficient



**OSRAM LEDriving® SL<sup>2</sup> product range**



Product Reference		Product Number	V	W		K		COLOR			
828DWP	PG18.5d-1 (P13W)	4062172150279	12	1.6	48.3	6000	-	Cool white	1	10	14 <sup>P.110</sup>
5201DWP	PG20-1 (PS19W)	4062172150293	12	1.6	42.5	6000	-	Cool white	1	10	15 <sup>P.110</sup>
2825DWP-02B	W2.1x9.5d (W5W)	4052899620810	12	0.8	25.0	6000	617-621	Cool white	2	20	20 <sup>P.110</sup>
2825DRP-02B	W2.1x9.5d (W5W)	4062172150316	12	0.6	25.0	-	617-621	Red	2	10	20 <sup>P.110</sup>
2827DYP-02B	W2.1x9.5d (W5W/WY5W)	4062172150330	12	0.5	25.0	-	592	Amber	2	10	20 <sup>P.110</sup>
921DWP-02B	W2.1x9.5d (W16W)	4062172150804	12	2.1	35.9	6000	-	Cool white	2	10	21 <sup>P.110</sup>
921DRP-02B	W2.1x9.5d (W16W)	4062172160155	12	1.4	35.9	-	617-621	Red	2	10	21 <sup>P.110</sup>
6438DWP-01B	SV8.5-8 (C5W)	4062172150637	12	1.0	31.0	6000	-	Cool white	1	5	11 <sup>P.110</sup>
6418DWP-01B	SV8.5-8 (C5W)	4062172150651	12	0.6	36.0	6000	-	Cool white	1	5	12 <sup>P.110</sup>
6413DWP-01B	SV8.5-8 (C5W)	4062172150675	12	0.6	41.0	6000	-	Cool white	1	5	13 <sup>P.110</sup>
7506DWP-02B	BA15s (P21W)	4062172152181	12	1.9	42.6	6000	-	Cool white	2	10	16 <sup>P.110</sup>
7506DRP-02B	BA15s (P21W)	4062172152204	12	1.3	42.6	-	617-621	Red	2	10	16 <sup>P.110</sup>
7506DYP-02B	BA15s (P21W)	4062172152228	12	1.3	42.6	-	592	Amber	2	10	16 <sup>P.110</sup>
7507DYP-02B	BAU15s (PY21W)	4062172152242	12	1.3	42.6	-	592	Amber	2	10	18 <sup>P.110</sup>
7515DWP-02B	W3x16q (W21/5W)	4062172152266	12	1.9	36.3	6000	-	Cool white	2	10	23 <sup>P.110</sup>
7515DRP-02B	W3x16d (W21/5W)	4062172152280	12	1.7	36.3	-	617-621	Red	2	10	23 <sup>P.110</sup>
7515DYP-02B	W3x16q (W21/5W)	4062172152303	12	1.3	36.3	-	592	Amber	2	10	23 <sup>P.110</sup>
7505DWP-02B	W3x16d (W21W)	4062172149235	12	2.0	36.3	6000	-	Cool white	2	10	22 <sup>P.110</sup>
7505DRP-02B	W3x16d (W21W)	4062172149259	12	1.4	36.3	-	617-621	Red	2	10	22 <sup>P.110</sup>
7505DYP-02B	W3x16d (W21W)	4062172149273	12	1.3	36.3	-	592	Amber	2	10	22 <sup>P.110</sup>
7504DYP-02B	WX3x16d (WY21W)	4062172156004	12	1.3	36.3	-	592	Amber	2	10	24 <sup>P.110</sup>
7528DWP-02B	BAY15d (P21/5W)	4062172151726	12	2.0	42.6	6000	-	Cool white	2	10	17 <sup>P.110</sup>
7528DRP-02B	BAY15d (P21/5W)	4062172151740	12	1.4	42.6	-	617-621	Red	2	10	17 <sup>P.110</sup>
7528DYP-02B	BAY15d (P21/5W)	4062172151702	12	1.3	42.6	-	592	Amber	2	10	17 <sup>P.110</sup>
3157DWP-02B	W3x16q (P27/7W)	4062172151641	12	2.0	42.6	6000	-	Cool white	2	10	19 <sup>P.110</sup>
3157DRP-02B	W3x16q (P27/7W)	4062172151689	12	1.4	42.6	-	617-621	Red	2	10	19 <sup>P.110</sup>
3157DYP-02B	W3x16q (P27/7W)	4062172151665	12	1.3	42.6	-	592	Amber	2	10	19 <sup>P.110</sup>
3893DWP-02B	BA9s (T4W)	4062172150354	12	0.8	27.8	6000	-	Cool white	2	10	25 <sup>P.110</sup>
5007DWP-02B	BA15s (R5W)	4062172222808	12	0.5	37.5	6000	-	Cool white	2	10	-
5008DWP-02B	BA15s (R10W)	4062172222846	12	1.2	37.5	6000	-	Cool white	2	10	-
2723DWP-02B	W2x4.6d (T5/W2.3W)	4062172254687	12	0.25	16.5	6000	-	Cool white	2	10	-

**i** Replace your conventional lamps with LED retrofit lamps.  
 Visit [www.osram.com/retrofit-exchange](http://www.osram.com/retrofit-exchange)

1) Refer to [www.osram.com/am-guarantee](http://www.osram.com/am-guarantee) for precise conditions | 2) These products do not have ECE approval and must not be used on public roads in any exterior application. Public roads use leads to cancellation of operating license and loss of insurance coverage. Several countries forbid sale and use of these products. Please contact your local distributor for further information. | 3) LEDriving® CANBUS CONTROL UNIT (P.37) avoid error messages on the board computer when using LED retrofits within 5W, 21W and 50 W applications.



## NEW OSRAM LEDriving® HLM

### Easy upgrade from conventional motorcycle headlights to cool white LED light

The OSRAM LEDriving® HLM represent an easy solution to upgrade conventional motorcycle headlights with cool white LED light – with a color temperature of 6,000 K, they provide a stylish and modern look as well as superior brightness. Equipped with the latest LED technology and a very compact design, these lamps allow high compatibility and an easy installation for a wide range of motorcycle models. The LEDriving® HLM lamps are 12 V and AC/DC compatible and offer a long service life.

#### Features<sup>1)</sup>

- Cool White color temperature of 6,000 K
- Superior brightness
- LED replacement for conventional HS1 and T19 high and low beam lamps
- Premium OSRAM quality
- Long lifetime
- Compact plug and play design

#### Benefits<sup>1)</sup>

- Better visibility thanks to daylight effect
- More light allows to see farther and therefore react sooner. Signs, obstacles and hazards can be recognized sooner
- Reduced glaring thanks to an optimized light distribution
- More durability due to LED technology
- Saves time and effort with less maintenance and garage visits
- Easy installation



**OSRAM LEDDriving® HLM motorcycle product range**

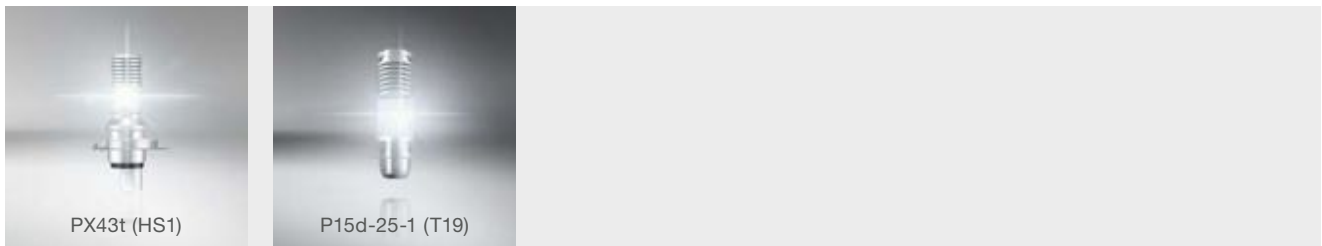

Product Reference		Product Number	V	W	K	COLOR			No.
64185DWP-01B	PX43t (HS1)	40621722 <b>29494</b>	12	5/5	6000	Cool White	1	5	26 <sup>P.110</sup>
7335DWP-01B	P15d-25-1 (T19) <sup>2)</sup>	40621722 <b>29531</b>	12	5/5	6000	Cool White	1	5	27 <sup>P.110</sup>

**i** Replace your conventional lamps with LED retrofit lamps.  
 Visit [www.osram.com/retrofit-exchange](http://www.osram.com/retrofit-exchange)

1) These products do not have ECE approval and must not be used on public roads in any exterior application. Public roads use leads to cancellation of operating license and loss of insurance coverage. Several countries forbid sale and use of these products. Please contact your local distributor for further information.  
 2) no ECE equivalent type



## NEW OSRAM LEDriving<sup>®</sup> HLT

### Bright light for trucks (24 V)

Simply replace old truck lamps with OSRAM's LED replacement lamps for forward lighting to benefit from highly energy-efficient bright LED light. LEDriving<sup>®</sup> HLT for high and low beam applications are 24 V compatible and stand out with very high brightness, high compatibility, easy installation and no radio disturbance.

#### Features<sup>1)</sup>

- Cool White color temperature of 6,000 K
- Superior brightness
- LED replacement for conventional H1, H4 or H7 high and low beam lamps
- Premium OSRAM quality
- Long lifetime
- With external driver, for more performance and robustness

#### Benefits<sup>1)</sup>

- Better visibility thanks to daylight effect
- More light allows to see farther and therefore react sooner. Signs, obstacles and hazards can be recognized sooner
- Reduced glaring thanks to an optimized light distribution
- 3-year OSRAM guarantee<sup>2)</sup>
- More durability due to LED technology
- Saves time and effort with less maintenance and garage visits





**OSRAM LEDDriving® HLT (24V) Truck product range**



Product Reference		Product Number	V	W	K	COLOR			
64155DWS-2HFB P14.5s (H1)		4062172183123	24	12	6000	Cool White	2	8	28 <sup>P.110</sup>
64196DWS-2HFB P43t (H4)		4062172183147	24	13/13	6000	Cool White	2	8	29 <sup>P.110</sup>
64215DWS-2HFB PX26d (H7)		4062172183161	24	18	6000	Cool White	2	8	30 <sup>P.110</sup>

**i** Replace your conventional lamps with LED retrofit lamps.  
 Visit [www.osram.com/retrofit-exchange](http://www.osram.com/retrofit-exchange)

1) These products do not have ECE approval and must not be used on public roads in any exterior application. Public roads use leads to cancellation of operating license and loss of insurance coverage. Several countries forbid sale and use of these products. Please contact your local distributor for further information.  
 2) Refer to [www.osram.com/am-guarantee](http://www.osram.com/am-guarantee) for precise conditions



## OSRAM LEDriving® ACCESSORIES

### Making LED upgrades fit right in

LED lamps are highly energy-efficient. But their lower wattages prompt board computer warnings. The OSRAM solution: the Canbus Control Unit. It prevents warnings and allows the lightsource to run cool and retain their brightness. Simply clip the warning canceller between lamp and socket, and enjoy the full benefits of your OSRAM LED retrofits and fog lights.

#### Features

- Bypasses the vehicle's outage detection system to prevent error messages in board computers prompted by LED lamps with lower wattages
- Available with power up to 50 W
- Robust component

#### Benefits

- Easily clips onto wires
- Enjoy full benefits of your OSRAM LED retrofits and fog lights
- Original OSRAM accessory
- 3-year guarantee<sup>1)</sup>



**OSRAM LEDriving® CANBUS product range**

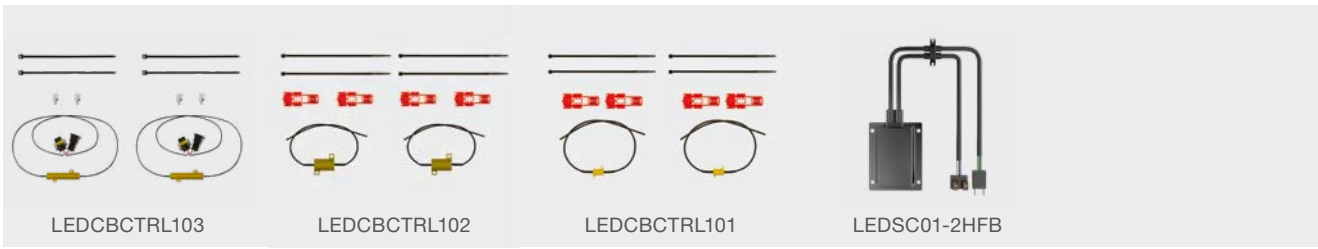

Product Reference	Product Number	V	W			No.
LEDSC01-2HFB <sup>2)</sup>	4062172 <b>191142</b>	12	12	2	4	-
LEDCBCTRL103	4052899 <b>327375</b>	12	50	2	10	-
LEDCBCTRL102	4052899 <b>301993</b>	12	21	2	10	-
LEDCBCTRL101	4052899 <b>090873</b>	12	5	2	10	-

**OSRAM ADAPTER<sup>3)</sup> product range**



Product Reference	Product Number	V	W			No.
64210DA01	4062172 <b>160384</b>	-	-	2	20	-
64210DA02	4062172 <b>160414</b>	-	-	2	20	-
64210DA03	4062172 <b>183840</b>	-	-	2	20	-
64210DA06	4062172 <b>183932</b>	-	-	2	20	-

**OSRAM CAP<sup>3)4)</sup> product range**



Product Reference	Product Number	V	W			No.
LEDCAP01	4062172 <b>241878</b>	-	-	2	8	-
LEDCAP02	4062172 <b>241908</b>	-	-	2	8	-
LEDCAP03	4062172 <b>271394</b>	-	-	2	8	-
LEDCAP04	4062172 <b>278560</b>	-	-	2	8	-

1) Refer to [www.osram.com/am-guarantee](http://www.osram.com/am-guarantee) for precise conditions | 2) LEDriving® SMART CANBUS avoids error messages on the board computer when using LED lamps | 3) Only suitable for  $\pm$ H7 lamps | 4) Off-road use only



## Xenon headlight lamps – fascinatingly bright

OSRAM xenon lamps generate up to 200% more brightness compared to the minimum legal standard – at impressive color temperatures, as well as significantly lower energy consumption and longer life than halogen lamps. OSRAM cutting-edge xenon lighting concepts, however, allow far more than just driving comfort, underlining personal style and demonstrating individual environmental awareness. They are suitable for cars, trucks, buses and commercial vehicles.



# OSRAM XENARC® NIGHT BREAKER® LASER

## Brightest OSRAM xenon light

With up to 200% more brightness on the road compared to the minimum legal standard, these exceptionally bright headlight lamps offer up to 20% whiter xenon light<sup>1)</sup> and a beam length of up to 250 m.



### Features

- Up to 200% more brightness<sup>1)</sup>
- Up to 250 m long beam
- Up to 20% whiter light<sup>1)</sup>
- Optimized light distribution for higher performance

### Benefits

- More light allows to see farther and therefore react sooner
- Better visibility
- Close to laser look
- Signs, obstacles and hazards can be recognized sooner



### OSRAM XENARC® NIGHT BREAKER® LASER product range

Product Reference	ECE	Product Number	V	W		lm	K			No.
66140XNL <sup>2)3)</sup>	D1S <sup>4)</sup>	4052899992870	85	35	PK32d-2	3200 <sup>5)</sup>	4500	1	4	1 <sup>P.116</sup>
66140XNL-HCB <sup>2)3)</sup>	D1S <sup>4)</sup>	4052899993013	85	35	PK32d-2	3200 <sup>5)</sup>	4500	2	4	1 <sup>P.116</sup>
66240XNL <sup>2)3)</sup>	D2S <sup>4)</sup>	4052899993259	85	35	P32d-2	3200 <sup>5)</sup>	4500	1	4	3 <sup>P.116</sup>
66240XNL-HCB <sup>2)3)</sup>	D2S <sup>4)</sup>	4052899992894	85	35	P32d-2	3200 <sup>5)</sup>	4500	2	4	3 <sup>P.116</sup>
66340XNL <sup>2)3)</sup>	D3S <sup>4)</sup>	4052899992979	42	35	PK32d-5	3200 <sup>5)</sup>	4400	1	4	1 <sup>P.116</sup>
66340XNL-HCB <sup>2)3)</sup>	D3S <sup>4)</sup>	4052899993099	42	35	PK32d-5	3200 <sup>5)</sup>	4400	2	4	1 <sup>P.116</sup>
66440XNL <sup>2)3)</sup>	D4S <sup>4)</sup>	4052899992993	42	35	P32d-5	3200 <sup>5)</sup>	4400	1	4	3 <sup>P.116</sup>
66440XNL-HCB <sup>2)3)</sup>	D4S <sup>4)</sup>	4052899993174	42	35	P32d-5	3200 <sup>5)</sup>	4400	2	4	3 <sup>P.116</sup>

1) Compared to minimum ECE R98/R99 requirements | 2) To be operated only with approved electronic control gear | 3) XENARC® lamps should be replaced by a qualified mechanic | 4) Reduced UV emission | For projection headlights | ECE approval and DOT label | 5) ± 450lm





# OSRAM XENARC® COOL BLUE® INTENSE

## Extra white light for LED look

Exceptionally bright, high contrast and brilliantly white for LED look with up to 6,200 K: The high-tech xenon light comes with a highly efficient technology, brilliant effect and no-compromise design.



### Features

- Extra white light for LED look
- Color temperatures of up to 6,200 K<sup>1)2)</sup>
- Up to 150% more brightness<sup>1)3)</sup>

### Benefits

- Modern look on the road
- High contrast
- More light allows to see farther and therefore react sooner



### OSRAM XENARC® COOL BLUE® INTENSE product range

Product Reference	ECE	Product Number	V	W		lm	K			
66140CBN <sup>4)5)</sup>	D1S <sup>6)</sup>	4062172157322	85	35	PK32d-2	3200 <sup>3)</sup>	6200	1	4	1 <sup>P.116</sup>
66140CBN-HCB <sup>4)5)</sup>	D1S <sup>6)</sup>	4062172145275	85	35	PK32d-2	3200 <sup>3)</sup>	6200	2	4	1 <sup>P.116</sup>
66240CBN <sup>4)5)</sup>	D2S <sup>6)</sup>	4062172157353	85	35	P32d-2	3200 <sup>3)</sup>	6200	1	4	3 <sup>P.116</sup>
66240CBN-HCB <sup>4)5)</sup>	D2S <sup>6)</sup>	4062172111362	85	35	P32d-2	3200 <sup>3)</sup>	6200	2	4	3 <sup>P.116</sup>
66250CBN <sup>4)5)</sup>	D2R <sup>7)</sup>	4062172216913	85	35	P32d-3	2800 <sup>3)</sup>	6000	1	4	4 <sup>P.116</sup>
66340CBN <sup>4)5)</sup>	D3S <sup>6)</sup>	4062172157384	42	35	PK32d-5	3200 <sup>3)</sup>	6200	1	4	1 <sup>P.116</sup>
66340CBN-HCB <sup>4)5)</sup>	D3S <sup>6)</sup>	4062172145305	42	35	PK32d-5	3200 <sup>3)</sup>	6200	2	4	1 <sup>P.116</sup>
66440CBN <sup>4)5)</sup>	D4S <sup>6)</sup>	4062172157414	42	35	P32d-5	3200 <sup>3)</sup>	6200	1	4	3 <sup>P.116</sup>
66440CBN-HCB <sup>4)5)</sup>	D4S <sup>6)</sup>	4062172145350	42	35	P32d-5	3200 <sup>3)</sup>	6200	2	4	3 <sup>P.116</sup>
66548CBN <sup>4)5)</sup>	D8S <sup>6)</sup>	4062172148412	42	25	PK32d-1	2000 <sup>3)</sup>	6200	1	4	1 <sup>P.116</sup>

1) D1S, D2S, D3S, D4S, D8S | 2) Measured in headlamps | 3) Compared to minimum ECE R98 requirements | 4) To be operated only with approved electronic control gear | 5) XENARC® lamps should be replaced by a qualified mechanic | 6) Reduced UV emission / For projection headlamps / ECE approval and DOT label | 7) Reduced UV emission | With anti-glare strip for reflection headlamps | ECE approval and DOT label | 8) ± 450 lm



# OSRAM XENARC® ULTRA LIFE

## Superior life and 10-year guarantee

For additional reliability: With up to four times the lifespan of a standard lamp, XENARC® ULTRA LIFE headlight lamps come with a 10-year guarantee<sup>1)</sup>.



### Features

- 10-year guarantee<sup>1)</sup>
- Up to 4 times longer lifetime<sup>2)</sup>
- Up to 300,000 km service life<sup>3)</sup>
- More durability

### Benefits

- Additional comfort due to reliable quality
- Saves time due to fewer workshop visits
- Additional reliability
- Longer replacement cycles



### OSRAM XENARC® ULTRA LIFE product range

Product Reference	ECE	Product Number	V	W		lm	K			No.
66140ULT <sup>4)5)</sup>	D1S <sup>6)</sup>	4052899 <b>425514</b>	85	35	PK32d-2	3200 <sup>7)</sup>	4300	1	4	1 <sup>P.116</sup>
66140ULT-HCB <sup>4)5)</sup>	D1S <sup>6)</sup>	4052899 <b>429598</b>	85	35	PK32d-2	3200 <sup>7)</sup>	4300	2	4	1 <sup>P.116</sup>
66240ULT <sup>4)5)</sup>	D2S <sup>6)</sup>	4052899 <b>425576</b>	85	35	P32d-2	3200 <sup>7)</sup>	4300	1	4	3 <sup>P.116</sup>
66240ULT-HCB <sup>4)5)</sup>	D2S <sup>6)</sup>	4052899 <b>429659</b>	85	35	P32d-2	3200 <sup>7)</sup>	4300	2	4	3 <sup>P.116</sup>
66340ULT <sup>4)5)</sup>	D3S <sup>6)</sup>	4052899 <b>425606</b>	42	35	PK32d-5	3200 <sup>7)</sup>	4300	1	4	1 <sup>P.116</sup>
66340ULT-HCB <sup>4)5)</sup>	D3S <sup>6)</sup>	4052899 <b>429710</b>	42	35	PK32d-5	3200 <sup>7)</sup>	4300	2	4	1 <sup>P.116</sup>
66440ULT <sup>4)5)</sup>	D4S <sup>6)</sup>	4052899 <b>425637</b>	42	35	P32d-5	3200 <sup>7)</sup>	4300	1	4	3 <sup>P.116</sup>
66440ULT-HCB <sup>4)5)</sup>	D4S <sup>6)</sup>	4052899 <b>429772</b>	42	35	P32d-5	3200 <sup>7)</sup>	4300	2	4	3 <sup>P.116</sup>

1) With online product registration. Refer to [www.osram.com/am-guarantee](http://www.osram.com/am-guarantee) for precise conditions and registration | 2) Compared to standard xenon lamps | 3) With an average annual mileage of 14,259 km and 60% light on | 4) To be operated only with approved electronic control gear | 5) XENARC® lamps should be replaced by a qualified mechanic | 6) Reduced UV emission | For projection headlights | ECE approval and DOT label | 7) ± 450 lm



# OSRAM XENARC® ORIGINAL

## 4-year guarantee

XENARC® ORIGINAL lamps impress with a wide product range and the reliable OEM quality. Successfully used in millions of new automobiles from renowned manufacturers, whether as standard initial equipment or original spare parts.



### Features

- 4-year guarantee<sup>1)</sup>
- OEM Quality
- Original spare parts that exceed all ECE minimum standards
- Wide product range

### Benefits

- Additional comfort due to reliable quality
- Tried and trusted in millions of vehicles of well-known manufacturers
- Premium quality made in Germany
- Suitable for many xenon headlights



**OSRAM XENARC® ORIGINAL product range**

Product Reference	ECE	Product Number	V	W		lm	K			
66140 <sup>2)3)</sup>	D1S <sup>4)</sup>	4008321184276	85	35	PK32d-2	3200 <sup>6)</sup>	4300	1	4	1 <sup>P.116</sup>
66140-1SCB <sup>2)3)</sup>	D1S <sup>4)</sup>	4052899600423	85	35	PK32d-2	3200 <sup>6)</sup>	4300	1	4	1 <sup>P.116</sup>
66150 <sup>2)3)</sup>	D1R <sup>5)</sup>	4052899339828	85	35	PK32d-3	2800 <sup>6)</sup>	4300	1	4	2 <sup>P.116</sup>
66240 <sup>2)3)</sup>	D2S <sup>4)</sup>	4008321184573	85	35	P32d-2	3200 <sup>6)</sup>	4300	1	4	3 <sup>P.116</sup>
66240-1SCB <sup>2)3)</sup>	D2S <sup>4)</sup>	4052899600447	85	35	P32d-2	3200 <sup>6)</sup>	4300	1	4	3 <sup>P.116</sup>
66250 <sup>2)3)</sup>	D2R <sup>5)</sup>	4008321184634	85	35	P32d-3	2800 <sup>6)</sup>	4300	1	4	4 <sup>P.116</sup>
66340 <sup>2)3)</sup>	D3S <sup>4)</sup>	4052899199569	42	35	PK32d-5	3200 <sup>6)</sup>	4300	1	4	1 <sup>P.116</sup>
66340-1SCB <sup>2)3)</sup>	D3S <sup>4)</sup>	4052899600485	42	35	PK32d-5	3200 <sup>6)</sup>	4300	1	4	1 <sup>P.116</sup>
66350 <sup>2)3)</sup>	D3R <sup>5)</sup>	4008321129857	42	35	PK32d-6	2800 <sup>6)</sup>	4300	1	4	2 <sup>P.116</sup>
66440 <sup>2)3)</sup>	D4S <sup>4)</sup>	4008321349392	42	35	P32d-5	3200 <sup>6)</sup>	4300	1	4	3 <sup>P.116</sup>
66440-1SCB <sup>2)3)</sup>	D4S <sup>4)</sup>	4052899600508	42	35	P32d-5	3200 <sup>6)</sup>	4300	1	4	3 <sup>P.116</sup>
66450 <sup>2)3)</sup>	D4R <sup>5)</sup>	4008321349576	42	35	P32d-6	2800 <sup>6)</sup>	4300	1	4	4 <sup>P.116</sup>
66540 <sup>3)</sup>	D5S <sup>4)</sup>	4052899600522	12	25	PK32d-7	2000 <sup>7)</sup>	4800	1	4	-
66548 <sup>2)3)</sup>	D8S <sup>4)</sup>	4008321787019	42	25	PK32d-1	2000 <sup>8)</sup>	4500	1	4	1 <sup>P.116</sup>

A perfectly matched OSRAM system solution with ballast, terminal and connecting cables is available for all XENARC® D1S/R, D3S/R and D8S lamps. Please consult your OSRAM contact if required.

- 1) Refer to [www.osram.com/am-guarantee](http://www.osram.com/am-guarantee) for precise conditions
- 2) To be operated only with approved electronic control gear
- 3) XENARC® lamps should be replaced by a qualified mechanic
- 4) Reduced UV emission | For projection headlights | ECE approval and DOT label
- 5) Reduced UV emission | With anti-glare strip for projection headlights | ECE approval and DOT label
- 6) ± 450 lm
- 7) + 300 lm/-200 lm
- 8) ± 300 lm



## Halogen lamps for cars – the most popular classic light, for good reason

Long life or high performance, optimized illumination, best quality, convincing price-performance ratio – for these excellent reasons, OSRAM halogen solutions are the best-selling classics among headlight lamps. From original, performance, design, and comfort products, each customer can choose the exact lamp which best fits their personal needs – whether it is an original spare part or a value-added product.





# OSRAM NIGHT BREAKER® 200

## Brightest OSRAM halogen light

Outshining all other OSRAM halogen lamps: NIGHT BREAKER® 200 headlight lamps excel with up to 200% more brightness compared to the minimum legal standard, up to 150 m long beam and new mirror chrome cap.



### Features

- Up to 200% more brightness<sup>1)</sup>
- Up to 150 m long beam
- Mirror chrome cap
- Up to 20% whiter light<sup>1)</sup>
- Brightest OSRAM halogen light

### Benefits

- More light allows to see farther and therefore react sooner
- Better visibility
- Modern look
- Signs, obstacles and hazards can be recognized sooner
- Premium quality made by OSRAM



### OSRAM NIGHT BREAKER® 200 product range

Product Reference	ECE	Product Number	V	W					No.
64193NB200	H4	4062172 <b>212281</b>	12	60/55	P43t	1	100		8 <sup>P.116</sup>
64193NB200-HCB	H4	4062172 <b>198158</b>	12	60/55	P43t5s	2	10		8 <sup>P.116</sup>
64210NB200	H7	4062172 <b>212250</b>	12	55	PX26d	1	100		9 <sup>P.116</sup>
64210NB200-HCB	H7	4062172 <b>198134</b>	12	55	PX26d	2	10		9 <sup>P.116</sup>

1) Compared to minimum ECE R112/R37 requirements



# OSRAM NIGHT BREAKER® LASER

## Halogen light with excellent brightness

Up to 150% brighter than the minimum legal standard: Innovative laser ablation technology makes NIGHT BREAKER® LASER the second most powerful OSRAM halogen lamp.



### Features

- Up to 150% more brightness<sup>1)</sup>
- Up to 150 m long beam
- Up to 20% whiter light<sup>1)</sup>
- More light performance due to innovative laser ablation technology<sup>2)</sup>
- Unique design with laser-etched product name<sup>2)</sup>

### Benefits

- More light allows to see farther and therefore react sooner
- Better visibility
- Modern look
- Signs, obstacles and hazards can be recognized sooner



### OSRAM NIGHT BREAKER® LASER product range

Product Reference	ECE	Product Number	V	W					No.
64150NL	H1	4052899991309	12	55	P14.5s	1	100		5 <sup>P.116</sup>
64150NL-01B	H1	4062172114936	12	55	P14.5s	1	10		5 <sup>P.116</sup>
64150NL-HCB	H1	4062172114899	12	55	P14.5s	2	10		5 <sup>P.116</sup>
64151NL	H3	4052899991330	12	55	PK22s	1	100		6 <sup>P.116</sup>
64151NL-HCB	H3	4062172114912	12	55	PK22s	2	10		6 <sup>P.116</sup>
64193NL	H4	4052899991361	12	60/55	P43t	1	100		7 <sup>P.116</sup>
64193NL-01B	H4	4062172114431	12	60/55	P43t	1	10		7 <sup>P.116</sup>
64193NL-HCB	H4	4062172114318	12	60/55	P43t	2	10		7 <sup>P.116</sup>
64210NL	H7	4052899991392	12	55	PX26d	1	100		8 <sup>P.116</sup>
64210NL-01B	H7	4062172114455	12	55	PX26d	1	10		8 <sup>P.116</sup>
64210NL-HCB	H7	4062172114332	12	55	PX26d	2	10		8 <sup>P.116</sup>
64212NL	H8	4052899998827	12	35	PGJ19-1	1	100		9 <sup>P.116</sup>
64212NL-HCB	H8	4062172114370	12	35	PGJ19-1	2	10		9 <sup>P.116</sup>
64211NL	H11	4052899991422	12	55	PGJ19-2	1	100		14 <sup>P.116</sup>
64211NL-01B	H11	4062172114479	12	55	PGJ19-2	1	10		14 <sup>P.116</sup>
64211NL-HCB	H11	4062172114356	12	55	PGJ19-2	2	10		14 <sup>P.116</sup>
9005NL	HB3	4052899998858	12	60	P20d	1	100		22 <sup>P.116</sup>
9005NL-HCB	HB3	4062172114394	12	60	P20d	2	10		22 <sup>P.116</sup>
9006NL	HB4	4052899998889	12	51	P22d	1	100		24 <sup>P.116</sup>
9006NL-HCB	HB4	4062172114417	12	51	P22d	2	10		24 <sup>P.116</sup>

1) Compared to minimum ECE R112/R37 requirements | 2) H4/H7/H8/H11/HB3/HB4



# OSRAM NIGHT BREAKER® SILVER

## Excellent performance-lifetime ratio

With up to 100% more brightness compared to the minimum legal standard, an excellent choice for motorists with high demands for performance and lifetime.



### Features

- Up to 100% more brightness<sup>1)</sup>
- Up to 130 m long beam
- Excellent performance-lifetime ratio

### Benefits

- More light allows to see farther and therefore react sooner
- Better visibility
- More light at a reasonable lifetime



### OSRAM NIGHT BREAKER® SILVER product range

Product Reference	ECE	Product Number	V	W				
								No.
64150NBS	H1	4052899992573	12	55	P14.5s	1	100	5 <sup>P.116</sup>
64150NBS-01B	H1	4052899992399	12	55	P14.5s	1	10	5 <sup>P.116</sup>
64150NBS-HCB	H1	4052899992252	12	55	P14.5s	2	10	5 <sup>P.116</sup>
64193NBS	H4	4052899992603	12	60/55	P43t	1	100	7 <sup>P.116</sup>
64193NBS-01B	H4	4052899992450	12	60/55	P43t	1	10	7 <sup>P.116</sup>
64193NBS-HCB	H4	4052899992337	12	60/55	P43t	2	10	7 <sup>P.116</sup>
64210NBS	H7	4052899992634	12	55	PX26d	1	100	8 <sup>P.116</sup>
64210NBS-01B	H7	4052899992511	12	55	PX26d	1	10	8 <sup>P.116</sup>
64210NBS-HCB	H7	4052899992719	12	55	PX26d	2	10	8 <sup>P.116</sup>
64211NBS	H11	4052899992665	12	55	PGJ19-2	1	100	14 <sup>P.116</sup>
64211NBS-HCB	H11	4052899992818	12	55	PGJ19-2	2	10	14 <sup>P.116</sup>

1) Compared to minimum ECE R112 requirements



# OSRAM COOL BLUE® INTENSE

## Extra white light for LED look

Stylish LED look for your drive: High-tech halogen lamp, almost in the league of LED lamps with their powerful extra white light.



### Features

- Extra white light for LED look
- Color temperatures of up to 5,000 K<sup>1)2)</sup>
- Up to 100% more brightness<sup>1)3)</sup>
- Modern design with silver cap<sup>4)</sup>

### Benefits

- Modern and stylish look
- High contrast
- More light allows to see farther and therefore react sooner
- Ideal for use in clear-glass headlights



### OSRAM COOL BLUE® INTENSE product range

Product Reference	ECE	Product Number	V	W					No.
64150CBN	H1	4058075520356	12	55	P14.5s	1	100		5 <sup>P.116</sup>
64150CBN-01B	H1	4062172251662	12	55	P14.5s	1	10		5 <sup>P.116</sup>
64150CBN-HCB	H1	4062172173681	12	55	P14.5s	2	10		5 <sup>P.116</sup>
64193CBN	H4	4062172149334	12	60/55	P43t	1	100		7 <sup>P.116</sup>
64193CBN-01B	H4	4062172251686	12	60/55	P43t	1	10		7 <sup>P.116</sup>
64193CBN-HCB	H4	4062172149297	12	60/55	P43t	2	10		7 <sup>P.116</sup>
64210CBN	H7	4062172149358	12	55	PX26d	1	100		8 <sup>P.116</sup>
64210CBN-01B	H7	4062172251709	12	55	PX26d	1	10		8 <sup>P.116</sup>
64210CBN-HCB	H7	4062172149310	12	55	PX26d	2	10		8 <sup>P.116</sup>
64212CBN-HCB	H8	4062172214988	12	35	PGJ19-1	2	10		9 <sup>P.116</sup>
64211CBN-HCB	H11	4062172214940	12	55	PGJ19-2	2	10		14 <sup>P.116</sup>
64176CBN	H15	4062172215527	12	55/15	PGJ23t-1	1	100		17 <sup>P.116</sup>
64176CBN-HCB	H15	4062172215008	12	55/15	PGJ23t-1	2	10		17 <sup>P.116</sup>
9005CBN-HCB	HB3	4062172215022	12	60	P20d	2	10		22 <sup>P.116</sup>
9006CBN-HCB	HB4	4062172215046	12	51	P22d	2	10		24 <sup>P.116</sup>
9012CBN	HIR2	4062172215572	12	55	PX22d	1	100		28 <sup>P.116</sup>
2825CBN	W5W	4062172218757	12	5	W2.1x9.5d	10	50		51 <sup>P.117</sup>
2825CBN-02B	W5W	4062172215060	12	5	W2.1x9.5d	2	20		51 <sup>P.117</sup>

1) H1, H4, H7, H11, HB3, HB4, HIR2 | 2) Measured in headlamps | 3) Compared to minimum ECE R112 requirements | 4) H4, H7, H8, H11, HB4



# OSRAM DIADEM® CHROME

## Only amber during operation

Visual tuning for indicator lights: The signal lights DIADEM® CHROME only emit amber light during operation – making them the perfect, attractive light supplement for halogen and xenon headlamps.



### Features

- Chrome design
- Amber when ON
- Homogenous appearance
- Cutting edge interference and absorber coating

### Benefits

- Thanks to cutting edge interference and absorber coating
- Only amber when operating, otherwise almost invisible
- Reflector has a fully homogenous chrome look
- Exclusive chrome look



### OSRAM DIADEM® CHROME product range

Product Reference	ECE	Product Number	V	W					Light No.
2827DC-02B <sup>1)</sup>	WY5W	4008321972750	12	5	W2.1x9.5d	2	20		51 <sup>P:117</sup>
7507DC-02B <sup>1)</sup>	PY21W	4008321972774	12	21	BAU15s	2	20		37 <sup>P:116</sup>

1) Amber lamps for clear indicator lights





# OSRAM ULTRA LIFE

## Longer life and 4-year guarantee

The ULTRA LIFE product family provides more reliability and durability. The lamps last up to four times longer compared with standard lamps and have a rock-solid guarantee of four years with online registration.



### Features

- 4-year guarantee<sup>1)</sup>
- Up to 4 times longer lifetime<sup>2)</sup>
- Up to 100,000 km service life<sup>3)</sup>
- More durability
- Modern design with silver cap (H4/H7/H11)

### Benefits

- Additional comfort due to reliable quality
- Saves time due to fewer workshop visits
- Additional reliability
- Longer replacement cycles
- Ideal for use in clear-glass headlights



**OSRAM ULTRA LIFE product range**

Product Reference	ECE	Product Number	V	W				
64150ULT	H1	4008321416209	12	55	P14.5s	1	100	5 <sup>P.116</sup>
64150ULT-01B	H1	4008321416100	12	55	P14.5s	1	10	5 <sup>P.116</sup>
64150ULT-HCB	H1	4008321416162	12	55	P14.5s	2	10	5 <sup>P.116</sup>
64193ULT	H4	4008321416230	12	60/55	P43t	1	100	7 <sup>P.116</sup>
64193ULT-01B	H4	4008321416124	12	60/55	P43t	1	10	7 <sup>P.116</sup>
64193ULT-HCB	H4	4008321416186	12	60/55	P43t	2	10	7 <sup>P.116</sup>
64210ULT	H7	4008321416261	12	55	PX26d	1	100	8 <sup>P.116</sup>
64210ULT-01B	H7	4052899436534	12	55	PX26d	1	10	8 <sup>P.116</sup>
64210ULT-HCB	H7	4052899436558	12	55	PX26d	2	10	8 <sup>P.116</sup>
64211ULT	H11	4052899431164	12	55	PGJ19-2	1	100	14 <sup>P.116</sup>
64211ULT-01B	H11	4052899436473	12	55	PGJ19-2	1	10	14 <sup>P.116</sup>
64211ULT-HCB	H11	4052899436510	12	55	PGJ19-2	2	10	14 <sup>P.116</sup>
7506ULT	P21W	4008321415349	12	21	BA15s	10	50	37 <sup>P.116</sup>
7506ULT-02B	P21W	4008321415141	12	21	BA15s	2	20	37 <sup>P.116</sup>
7507ULT <sup>3)</sup>	PY21W	4008321413147	12	21	BAU15s	10	50	37 <sup>P.116</sup>
7507ULT-02B <sup>4)</sup>	PY21W	4008321415165	12	21	BAU15s	2	20	37 <sup>P.116</sup>
7528ULT	P21/5W	4008321413116	12	21/5	BAY15d	10	50	38 <sup>P.116</sup>
7528ULT-02B	P21/5W	4008321415288	12	21/5	BAY15d	2	20	38 <sup>P.116</sup>
2825ULT	W5W	4008321413024	12	5	W2.1x9.5d	10	50	51 <sup>P.117</sup>
2825ULT-02B	W5W	4008321415189	12	5	W2.1x9.5d	2	20	51 <sup>P.117</sup>
5007ULT	R5W	4008321415370	12	5	BA15s	10	50	47 <sup>P.117</sup>
5007ULT-02B	R5W	4008321415202	12	5	BA15s	2	20	47 <sup>P.117</sup>
5008ULT	R10W	4008321415400	12	10	BA15s	10	50	47 <sup>P.117</sup>
5008ULT-02B	R10W	4008321415226	12	10	BA15s	2	20	47 <sup>P.117</sup>
6418ULT	C5W	4008321413086	12	5	SV8.5-8	10	50	35 <sup>P.116</sup>
6418ULT-02B	C5W	4008321415240	12	5	SV8.5-8	2	20	35 <sup>P.116</sup>
64132ULT	H6W	4008321413178	12	6	BAX9s	10	50	36 <sup>P.116</sup>
64132ULT-02B	H6W	4008321415325	12	6	BAX9s	2	20	36 <sup>P.116</sup>
64137ULT <sup>4)</sup>	HY21W	4052899910256	12	21	BAW9s	10	50	34 <sup>P.116</sup>

1) 4th year with online product registration. Refer to [www.osram.com/am-guarantee](http://www.osram.com/am-guarantee) for precise conditions and registration  
 2) Compared with standard lamps  
 3) With an average annual mileage of 14,259 km and 60% light on  
 4) Amber lamps for clear indicator lights



# OSRAM ORIGINAL LINE 12 V

## Original spare part

Convincing performance for standard requirements, robust and cost-effective: Successfully used in millions of new cars from renowned manufacturers, whether as standard initial equipment or original spare parts.



### Features

- OEM Quality
- Original spare parts that exceed all ECE minimum standards
- Wide product range

### Benefits

- Tried and trusted in millions of vehicles of well-known manufacturers
- Premium quality made in Germany
- Suitable for the most common applications

### OSRAM history

In 1925, OSRAM showcased the world a simple, yet ingenious solution – a lamp with two filaments, one for dipped beam and one for high beam. The BILUX® lamp was born and specifically registered to OSRAM. This enabled all the functions, which previously took up a lot of space and required complex mechanical designs, to be combined in one single light source. The lamp produced two beams with different strengths and angles in one single reflector.

Headlight manufacturers reacted quickly, and this technology became the typical light in all conventional vehicles in the 60s and even the 70s. It's still available today in its original form. The first generation of the OSRAM BILUX® lamps generally had a **P45t base** and an electrical output of **40/45 W**.



### OSRAM ORIGINAL LINE 12 V headlight lamps / auxiliary lamps product range

Product Reference	ECE	Product Number	V	W				
64150	H1	4050300001487	12	55	P14.5s	1	100	5 <sup>P.116</sup>
64150-01B	H1	4050300925264	12	55	P14.5s	1	10	5 <sup>P.116</sup>
64151	H3	4050300001494	12	55	PK22s	1	100	6 <sup>P.116</sup>
64151-01B	H3	4050300925349	12	55	PK22s	1	10	6 <sup>P.116</sup>
64193	H4	4050300001470	12	60/55	P43t	1	100	7 <sup>P.116</sup>



**OSRAM ORIGINAL LINE 12 V headlight lamps / auxiliary lamps product range**

Product Reference	ECE	Product Number	V	W					No.
64193-01B	H4	4050300 <b>925127</b>	12	60/55	P43t	1	10	7 <sup>P.116</sup>	
64210	H7	4050300 <b>332185</b>	12	55	PX26d	1	100	8 <sup>P.116</sup>	
64210-01B	H7	4050300 <b>925202</b>	12	55	PX26d	1	10	8 <sup>P.116</sup>	
64212	H8	4050300 <b>498751</b>	12	35	PGJ19-1	1	100	9 <sup>P.116</sup>	
64212-01B	H8	4052899 <b>262478</b>	12	35	PGJ19-1	1	10	9 <sup>P.116</sup>	
64242 <sup>1)</sup>	H8B	400832 <b>1055422</b>	12	35	PGJY19-1	1	100	10 <sup>P.116</sup>	
64213	H9	4050300 <b>524368</b>	12	65	PGJ19-5	1	100	11 <sup>P.116</sup>	
64243 <sup>1)</sup>	H9B	400832 <b>1055477</b>	12	65	PGJY19-5	1	100	12 <sup>P.116</sup>	
9145	H10	4052899 <b>348622</b>	12	42	PY20d	1	100	13 <sup>P.116</sup>	
64211	H11	4050300 <b>524313</b>	12	55	PGJ19-2	1	100	14 <sup>P.116</sup>	
64211-01B	H11	400832 <b>1171252</b>	12	55	PGJ19-2	1	10	14 <sup>P.116</sup>	
64241 <sup>1)</sup>	H11B	400832 <b>1054654</b>	12	55	PGJY19-2	1	100	15 <sup>P.116</sup>	
9008	H13	400832 <b>1939401</b>	12	60/55	P26.4t	1	10	16 <sup>P.116</sup>	
64176	H15	400832 <b>1218391</b>	12	55/15	PGJ23t-1	1	100	17 <sup>P.116</sup>	
64219L+	H16	400832 <b>1626783</b>	12	19	PGJ19-3	1	100	18 <sup>P.116</sup>	
64180L	H18	4052899 <b>479968</b>	12	55	PY26d-1	1	100	19 <sup>P.116</sup>	
64181L	H19	4052899 <b>599017</b>	12	60/55	PU43t-3	1	100	20 <sup>P.116</sup>	
880	H27W/1	400832 <b>1542977</b>	12	27	PG13	1	100	31 <sup>P.116</sup>	
881	H27W/2	400832 <b>1543004</b>	12	27	PGJ13	1	100	31 <sup>P.116</sup>	
9005	HB3	4050300 <b>137193</b>	12	60	P20d	1	100	22 <sup>P.116</sup>	
9005-01B	HB3	400832 <b>1171214</b>	12	60	P20d	1	10	22 <sup>P.116</sup>	
9005XS	HB3A	4052899 <b>982567</b>	12	60	P20d	1	100	23 <sup>P.116</sup>	
9006	HB4	4050300 <b>012650</b>	12	51	P22d	1	100	24 <sup>P.116</sup>	
9006-01B	HB4	400832 <b>1171238</b>	12	51	P22d	1	10	24 <sup>P.116</sup>	
9006XS	HB4A	400832 <b>1554284</b>	12	51	P22d	1	100	25 <sup>P.116</sup>	
9007	HB5	4050300 <b>148816</b>	12	65/55	PX29t	1	200	26 <sup>P.116</sup>	
9011	HIR1	400832 <b>1863966</b>	12	65	PX20d	1	100	27 <sup>P.116</sup>	
9012	HIR2	400832 <b>1863997</b>	12	55	PX22d	1	100	27 <sup>P.116</sup>	
7506	P21W	4050300 <b>838120</b>	12	21	BA15s	10	50	37 <sup>P.116</sup>	
7506-02B	P21W	Page 132	12	21	BA15s	2	20	37 <sup>P.116</sup>	
7507 <sup>2)</sup>	PY21W	4050300 <b>0891477</b>	12	21	BAU15s	10	50	37 <sup>P.116</sup>	
7507-02B <sup>2)</sup>	PY21W	Page 132	12	21	BAU15s	2	20	37 <sup>P.116</sup>	
7225	P21/4W	4050300 <b>0891514</b>	12	21/4	BAZ15d	10	50	38 <sup>P.116</sup>	
7225-02B	P21/4W	Page 132	12	21/4	BAZ15d	2	20	38 <sup>P.116</sup>	
7240	-	4050300 <b>0838007</b>	12	21/5	BA15d	10	50	38 <sup>P.116</sup>	
7528	P21/5W	4050300 <b>0838069</b>	12	21/5	BAY15d	10	50	38 <sup>P.116</sup>	
7528-02B	P21/5W	Page 132	12	21/5	BAY15d	2	20	38 <sup>P.116</sup>	
3860	-	400832 <b>1095756</b>	12	5	BA9s	10	50	48 <sup>P.117</sup>	
3893	T4W	4050300 <b>0838489</b>	12	4	BA9s	10	50	48 <sup>P.117</sup>	
3893-02B	T4W	Page 132	12	4	BA9s	2	20	48 <sup>P.117</sup>	
2820	-	400832 <b>1094094</b>	12	2	W2.1x9.5d	10	50	50 <sup>P.117</sup>	
2821	W3W	4050300 <b>0838663</b>	12	3	W2.1x9.5d	10	50	50 <sup>P.117</sup>	
2821-02B	W3W	Page 132	12	3	W2.1x9.5d	2	20	50 <sup>P.117</sup>	
2825	W5W	4050300 <b>0838632</b>	12	5	W2.1x9.5d	10	50	51 <sup>P.117</sup>	
2825-02B	W5W	Page 132	12	5	W2.1x9.5d	2	20	51 <sup>P.117</sup>	
2827NA <sup>2)</sup>	WY5W	4052899 <b>570795</b>	12	5	W2.1x9.5d	10	50	51 <sup>P.117</sup>	
2827NA-02B <sup>2)</sup>	WY5W	Page 132	12	5	W2.1x9.5d	2	20	51 <sup>P.117</sup>	
2886X	-	400832 <b>1094667</b>	12	6	W2.1x9.5d	10	50	51 <sup>P.117</sup>	
921	W16W	400832 <b>1100948</b>	12	16	W2.1x9.5d	10	50	52 <sup>P.117</sup>	
921-02B	W16W	Page 132	12	16	W2.1x9.5d	2	20	52 <sup>P.117</sup>	
921NA <sup>2)</sup>	WY16W	4052899 <b>230460</b>	12	16	W2.1x9.5d	10	50	53 <sup>P.117</sup>	
7504 <sup>2)</sup>	WY21W	400832 <b>1165473</b>	12	21	WX3x16d	10	50	54 <sup>P.117</sup>	
7505	W21W	4052899 <b>324244</b>	12	21	W3x16d	10	50	54 <sup>P.117</sup>	
7505-02B	W21W	Page 132	12	21	W3x16d	2	20	54 <sup>P.117</sup>	
7515	W21/5W	4052899 <b>324312</b>	12	21/5	W3x16q	10	50	55 <sup>P.117</sup>	
7515-02B	W21/5W	Page 132	12	21/5	W3x16q	2	20	55 <sup>P.117</sup>	
2721	-	4050300 <b>0838540</b>	12	1.2	W2x4.6d	10	50	57 <sup>P.117</sup>	



## OSRAM ORIGINAL LINE 12 V headlight lamps / auxiliary lamps product range

Product Reference	ECE	Product Number	V	W					No.
2721-02B	-	Page 132	12	1.2	W2x4.6d	2	20	57 <sup>P.117</sup>	
2722	-	4008321094803	12	2	W2x4.6d	10	50	57 <sup>P.117</sup>	
2722-02B	-	Page 132	12	2	W2x4.6d	2	20	57 <sup>P.117</sup>	
2723	W2.3W	4008321094834	12	2.3	W2x4.6d	10	50	49 <sup>P.117</sup>	
64132	H6W	4008321094896	12	6	BAX9s	10	50	36 <sup>P.116</sup>	
64136	H21W	4008321095190	12	21	BAY9s	10	50	33 <sup>P.116</sup>	
5007	R5W	4050300838427	12	5	BA15s	10	50	47 <sup>P.117</sup>	
5007-02B	R5W	Page 132	12	5	BA15s	2	20	47 <sup>P.117</sup>	
5008	R10W	4050300838212	12	10	BA15s	10	50	47 <sup>P.117</sup>	
5008-02B	R10W	Page 132	12	10	BA15s	2	20	47 <sup>P.117</sup>	
5009 <sup>2)</sup>	RY10W	4008321095442	12	10	BAU15s	10	50	47 <sup>P.117</sup>	
6411	-	4050300891354	12	10	SV8.5-8	10	50	60 <sup>P.117</sup>	
6411-02B	-	Page 132	12	10	SV8.5-8	2	20	60 <sup>P.117</sup>	
64111 <sup>3)</sup>	-	4008321095015	12	5	BA9s	10	50	64 <sup>P.117</sup>	
64111-02B <sup>3)</sup>	-	Page 133	12	5	BA9s	2	20	64 <sup>P.117</sup>	
64113	-	4008321095046	12	10	BA9s	10	50	64 <sup>P.117</sup>	
64115	-	4008321095077	12	20	BA9s	10	50	64 <sup>P.117</sup>	
6413	-	4050300891439	12	5	SV8.5-8	10	50	60 <sup>P.117</sup>	
6418	C5W	4050300838397	12	5	SV8.5-8	10	50	35 <sup>P.116</sup>	
6418-02B	C5W	Page 133	12	5	SV8.5-8	2	20	35 <sup>P.116</sup>	
6428	-	4008321094384	12	3	SV7-8	10	50	61 <sup>P.117</sup>	
6438	-	4008321094353	12	10	SV8.5-8	10	50	62 <sup>P.117</sup>	
6438-02B	-	Page 133	12	10	SV8.5-8	2	20	62 <sup>P.117</sup>	
6461	-	4008321094261	12	10	SV8.5-8	10	50	63 <sup>P.117</sup>	
6486X	-	4008321094292	12	6	SV8.5-8	10	50	-	
2351MFX6	-	4008321096852	12	1.2	BX8.4d	10	50	65 <sup>P.117</sup>	
2352MFX6	-	4008321097149	12	2	BX8.4d	10	50	66 <sup>P.117</sup>	
2452MFX6	-	4008321097118	12	1.5	BX8.4d	10	50	67 <sup>P.117</sup>	
2473MFX6	-	4008321096821	12	1.12	BX8.4d	10	50	68 <sup>P.117</sup>	
2721MFX	-	4008321297150	12	1.2	BX8.5d	10	50	70 <sup>P.117</sup>	
2722MFX	-	4008321297181	12	2	BX8.5d	10	50	72 <sup>P.117</sup>	
2721MF	-	4050300891255	12	1.2	B8.5d	10	50	69 <sup>P.117</sup>	
2722MF	-	4008321096791	12	2	B8.5d	10	50	71 <sup>P.117</sup>	
828	P13W	4062172094283	12	13	PG18,5d-1	1	100	74 <sup>P.117</sup>	
3156	P27W	4008321090621	12	27	W2.5x16d	10	50	39 <sup>P.116</sup>	
3157	P27/7W	4052899183414	12	27/7	W2.5x16q	10	50	40 <sup>P.116</sup>	
3757AK <sup>2)</sup>	PY27/7W	4052899178731	12	27/7	WX2.5x16q	10	50	41 <sup>P.116</sup>	
3796	-	4050300891309	12	2	Ba9s	10	50	59 <sup>P.117</sup>	
5201	PS19W	4052899600546	12	19	PG20-1	1	100	44 <sup>P.117</sup>	
5202	PS24W	4052899600584	12	24	PG20-3	1	100	45 <sup>P.117</sup>	
2504	PSX24W	4052899600560	12	24	PG20-7	1	100	46 <sup>P.117</sup>	
6851	PSX26W	4062172160100	12	26	PG18.5d-3	1	100	74 <sup>P.117</sup>	

1) Successor type for BILUX®-AS® lamp (product reference 7951)

2) Amber lamps for clear indicator lights

3) Also available with glass base (product reference 6411150 or 6411350)

The suffix on the product reference indicates the board thickness:

MFX6: 1.5mm

MF: 2.0mm

MFX: 1.5mm





# OSRAM MINIBOX

## Mobile lamp replacement

Defects in a vehicle usually make themselves known on long journeys. The OSRAM MINIBOX saves you the trouble of searching for a suitable workshop to purchase replacement lamps. You can therefore easily fix the problem yourself.



### Features

- Range of most important spare lamps
- Clear labeling and application illustration
- Reserve light for cars
- Original spare parts that exceed all ECE minimum standards

### Benefits

- You'll always have the right spare lamps at hand
- Easy identification
- Mandatory in many countries
- Premium quality made in Germany

### OSRAM MINIBOX product range



#### H1 ORIGINAL box

The H1 box is equipped with one H1 headlight lamp and contains the following five most important spare lamps and three flat fuses.

#### H4 ORIGINAL box

The H4 box is equipped with one H4 headlight lamp and contains the following five most important spare lamps and three flat fuses.

#### H7 ORIGINAL box

The H7 box is equipped with one H7 headlight lamp and contains the following five most important spare lamps and three flat fuses.

#### H1/H7 ORIGINAL box

The H1/H7 box is equipped with one H1 and one H7 headlight lamp and contains the following five most important spare lamps and three flat fuses.

	Product Number	Product Reference	ECE	i
H1 box	4050300875217	CLK H1	H1	Headlight + five spare lamps and three flat fuses
H4 box	4050300873398	CLK H4	H4	Headlight + five spare lamps and three flat fuses
H7 box	4050300876375	CLK H7	H7	Headlight + five spare lamps and three flat fuses
H1/H7 box	4052899522640	CLK H1/H7	H1/H7	Headlights + five spare lamps and three flat fuses
All boxes		7506	P21W	Brake and tail light
		7507	PY21W	Indicator light, amber
		7528	P21/5W	Brake/tail light
		5007	R5W	Tail light and license plate light
		2825	W5W	Parking light
				15A, 20A, 30A flat fuses



## Halogen lamps for buses and trucks – extreme durability, extreme high-performance

Truck and commercial vehicle lamps in daily use are often pushed to their performance limit. Lighting systems must therefore be enormously durable and extremely reliable – only then can they provide perfect light until the end of each run. The extremely long life of OSRAM high performance solutions enhances driving comfort and reduces maintenance time and fleet costs. Vehicle drivers and fleet managers can choose from a wide range of high performance truck lamps at OSRAM. All lighting solutions not only meet the highest quality requirements and offer OEM quality, but also exceed even European standards.



# OSRAM TRUCKSTAR® PRO

## Brightest OSRAM truck light

Extra lifetime, up to 120% more brightness compared to the minimum legal standard and very high vibration resistance are ideal for professional drivers while reducing downtime and fleet costs.



### Features

- Up to 2.5x more lifetime<sup>1)</sup>
- Up to 120% more brightness<sup>2)3)</sup>
- Very high vibration resistance

### Benefits

- Reduced downtime and fleet costs
- More light allows to see farther and therefore react sooner
- Suitable for heavy duty applications



### OSRAM TRUCKSTAR® PRO product range

Product Reference	ECE	Product Number	V	W					No.
64155TSP	H1	4008321784179	24	70	P14.5s	1	100		5 <sup>P.116</sup>
64155TSP-HCB	H1	4062172174657	24	70	P14.5s	2	10		5 <sup>P.116</sup>
64156TSP	H3	4008321784261	24	70	PK22s	1	100		6 <sup>P.116</sup>
64196TSP	H4	4008321785046	24	75/70	P43t	1	100		7 <sup>P.116</sup>
64196TSP-HCB	H4	4062172150439	24	75/70	P43t	2	10		7 <sup>P.116</sup>
64215TSP	H7	4008321785114	24	70	PX26d	1	100		8 <sup>P.116</sup>
64215TSP-HCB	H7	4062172150453	24	70	PX26d	2	10		8 <sup>P.116</sup>
64216TSP	H11	4052899904804	24	70	PGJ19-2	1	100		15 <sup>P.116</sup>
64216TSP-HCB	H11	4062172150477	24	70	PGJ19-2	2	10		15 <sup>P.116</sup>
7510TSP <sup>4)</sup>	PY21W	4008321798169	24	21	BAU15s	10	50		37 <sup>P.116</sup>
7511TSP	P21W	4052899340459	24	21	BA15s	10	50		37 <sup>P.116</sup>
7537TSP	P21/5W	4008321798138	24	21/5	BAY15d	10	50		38 <sup>P.116</sup>
2845TSP	W5W	4008321798077	24	5	W2.1x9.5d	10	50		51 <sup>P.117</sup>
5627TSP	R5W	4008321795151	24	5	BA15s	10	50		47 <sup>P.117</sup>
5637TSP	R10W	4008321795205	24	10	BA15s	10	50		47 <sup>P.117</sup>
3930TSP	T4W	4008321795106	24	4	BA9s	10	50		48 <sup>P.117</sup>

1) Compared with standard lamps | 2) H1, H4, H7, H11 | 3) Compared to minimum ECE R112 requirements | 4 Amber lamps for clear indicator lights



# OSRAM ORIGINAL LINE 24 V

## Original spare part for trucks

A balanced and economic solution for all standard requirements in the 24 V sector. Successfully used in millions of new vehicles from renowned manufacturers, whether as standard initial equipment or original spare parts.



### Features

- OEM Quality
- Original spare parts that exceed all ECE minimum standards
- Wide product range

### Benefits

- Tried and trusted in millions of vehicles of well-known manufacturers
- Premium quality made in Europe
- Suitable for the most common applications

---

The suffix on the product reference indicates the board thickness:

MF: 2.0 mm

MFX: 1.5 mm



**OSRAM ORIGINAL LINE 24 V headlight lamps / auxiliary lamps product range**

Product Reference	ECE	Product Number	V	W					No.
64155	H1	4050300016498	24	70	P14.5s	1	100	5 <sup>P.116</sup>	
64156	H3	4050300016535	24	70	PK22s	1	100	6 <sup>P.116</sup>	
64196	H4	4050300016542	24	75/70	P43t	1	100	7 <sup>P.116</sup>	
94196	H4	4050300250632	24	75/70	P43t	1	100	7 <sup>P.116</sup>	
64215	H7	4050300386522	24	70	PX26d	1	100	8 <sup>P.116</sup>	
64177	H15	4008321536556	24	20/60	PGJ23t-1	1	100	17 <sup>P.116</sup>	
7511	P21W	4050300838090	24	21	BA15s	10	50	37 <sup>P.116</sup>	
7537	P21/5W	4050300838038	24	21/5	BAY15d	10	50	38 <sup>P.116</sup>	
7529	-	4050300891774	24	15	BA15s	10	50	37 <sup>P.116</sup>	
5626	R5W	4008321095336	24	5	BA15d	10	50	47 <sup>P.117</sup>	
5627	R5W	4050300838335	24	5	BA15s	10	50	47 <sup>P.117</sup>	
5637	R10W	4050300831459	24	10	BA15s	10	50	47 <sup>P.117</sup>	
3797	-	4050300891668	24	2	BA9s	10	50	48 <sup>P.117</sup>	
3930	T4W	4050300838366	24	4	BA9s	10	50	48 <sup>P.117</sup>	
64138	H21W	4008321094988	24	21	BAY9s	10	50	33 <sup>P.117</sup>	
2341	-	4008321132529	24	1	W2x4.6d	10	50	56 <sup>P.117</sup>	
2840	-	4008321094698	24	2	W2.1x9.5d	10	50	58 <sup>P.117</sup>	
2841	W3W	4008321094728	24	3	W2.1x9.5d	10	50	50 <sup>P.117</sup>	
2845	W5W	4050300891552	24	5	W2.1x9.5d	10	50	51 <sup>P.117</sup>	
2741	-	4050300838519	24	1.2	W2x4.6d	10	50	57 <sup>P.117</sup>	
6421	-	4008321090768	24	3	SV8.5-8	10	50	60 <sup>P.117</sup>	
6423	C5W	4050300831435	24	5	SV8.5-8	10	50	35 <sup>P.116</sup>	
6424	-	4050300891712	24	5	SV8.5-8	10	50	60 <sup>P.117</sup>	
6429	-	4008321090836	24	10	SV8.5-8	10	50	60 <sup>P.117</sup>	
6430	-	4008321094414	24	3	SV8.5-8	10	50	61 <sup>P.117</sup>	
2741MF <sup>1)</sup>	-	4050300891606	24	1.2	B8.5d	10	50	73 <sup>P.117</sup>	
2741MFX <sup>1)</sup>	-	4008321297211	24	1.2	BX8.5d	10	50	73 <sup>P.117</sup>	





# OSRAM spare lamp kit 24 V

## Reserve light for trucks and buses

Professional truck drivers in particular rely on spare lamp kits from OSRAM. They can be used to repair faults without assistance or major work, wherever required.



### Features

- Range of most important spare lamps
- Clear labeling and application illustration
- Original spare parts that exceed all ECE minimum standards

### Benefits

- You'll always have the right spare lamps at hand
- Easy identification
- Premium quality made in Germany



## OSRAM spare lamp box, 24 V product range

### H7 TRUCKSTAR® PRO box

The TRUCKSTAR® PRO box is equipped with two H7 TRUCKSTAR® PRO headlight lamps and contains the following double sets of the six most important spare lamps and three flat fuses.

**Product Number:** 4008321809063

**Product Reference**

ECE



64215TSP	H7	Headlight
7511TSP	P21W	Brake and tail light
7510TSP	PY21W	Indicator light, amber
7537TSP	P21/5W	Brake/tail light
5627TSP	R5W	Tail light and license plate light
5637TSP	R10W	Parking light
3930TSP	T4W	Park and position light
		15A, 20A, 30A flat fuses

### H4 ORIGINAL box

The H4 box is equipped with two H4 headlight lamps and contains the following double sets of the six most important spare lamps and three flat fuses.

**Product Number:** 4008321583192

**Product Reference**

ECE



64196	H4	Headlight
7511	P21W	Brake and tail light
7510TSP	PY21W	Indicator light, amber
7537	P21/5W	Brake/tail light
5627	R5W	Tail light and license plate light
5637	R10W	Parking light
3930	T4W	Park and position light
		15A, 20A, 30A flat fuses

### H7 ORIGINAL box

The H7 box is equipped with two H7 headlight lamps and contains the following double sets of the six most important spare lamps and three flat fuses.

**Product Number:** 4008321583215

**Product Reference**

ECE



64215	H7	Headlight
7511	P21W	Brake and tail light
7510TSP	PY21W	Indicator light, amber
7537	P21/5W	Brake/tail light
5627	R5W	Tail light and license plate light
5637	R10W	Parking light
3930	T4W	Park and position light
		15A, 20A, 30A flat fuses





## Halogen lamps for motorcycles and scooters – safety first

Motorcycles, mopeds, or scooters are all too often overlooked in traffic – especially at night. The right lighting can save lives. Drivers of motorized two-wheelers value OSRAM motorcycle lamps for their high performance and high vibration resistance proven in tests. Alongside increased safety, OSRAM offers bikers with motorcycle lamps a wide variety of customization options from the design, performance, and original portfolio.

**Please note: the dedicated motorcycle portfolio will be discontinued step-by-step. OSRAM offers a wide range of lighting product for car and motorcycle use – please refer to the extensive vehicle lighting portfolio.**



# OSRAM motorcycle lamps

## Vibration-resistant technology

Power and emotion, for relaxed cruisers and sportive drivers. OSRAM's wide range of high performance, design, comfort and original products for 12 V can be equally installed in motorcycles. Dedicated motorcycle types are offered as OSRAM ORIGINAL.



### Features

- OEM Quality
- Original spare parts that exceed all ECE minimum standards
- Wide product range

### Benefits

- Tried and trusted in millions of vehicles of well-known manufacturers
- Premium quality
- Suitable for the most common headlights

Please see pages 45-55 for 12 V range which is fitting for motorcycles.



### OSRAM ORIGINAL product range

Product Reference	ECE	Product Number	V	W				
64326	S1	4052899 <b>157774</b>	12	25/25	BA20d	1	100	32 <sup>P.116</sup>
64327	S2	4052899 <b>136755</b>	12	35/35	BA20d	1	100	32 <sup>P.116</sup>
64327-01B	S2	4052899 <b>929692</b>	12	35/35	BA20d	1	10	32 <sup>P.116</sup>
64185	HS1	4050300 <b>439969</b>	12	35/35	PX43t	1	100	29 <sup>P.116</sup>
64185-01B	HS1	4052899 <b>253513</b>	12	35/35	PX43t	1	10	29 <sup>P.116</sup>





## Lamps for off-road use – best light, even off-road<sup>1)</sup>

Whether for competitions and races, construction and transport work, agriculture and forestry, or an enthusiast off-roader, driving off-road demands everything of lighting systems. Thanks to many years of experience in off-road driving, OSRAM knows exactly what these drivers want. In addition to robustness, resistance, and stability, above all they want outstanding and reliable lighting performance. The answer is a strong OSRAM product range of off-road lamps with high wattage that impress with excellent brightness and high color temperature in absolutely any environment.





# SUPER BRIGHT PREMIUM / SUPER BRIGHT

## Extra power for off-road use

With a strong portfolio of high-wattage off-road lamps with extra power, OSRAM provides solutions for even the most unusual requirements. All lamps are designed and designated for off-road use only and not permitted on public roads<sup>1)</sup>.



### Features<sup>1)</sup>

- Extra power due to high wattage
- Excellent brightness
- Rugged and versatile

### Benefits<sup>1)</sup>

- For the most difficult terrain: rescue services, construction and transport work, agriculture and forestry
- More light allows to see farther and therefore react sooner
- Solution for even the most unusual requirements



### OSRAM SUPER BRIGHT PREMIUM / SUPER BRIGHT high-performance headlamps<sup>1)</sup> – product range

Product Reference		Product Number	V	W			No.
62200SBP	P14.5s (H1)	4052899 <b>126282</b>	12	100	1	100	5 <sup>P.116</sup>
62201SBP	PK22s (H3)	4052899 <b>126312</b>	12	100	1	100	6 <sup>P.116</sup>
62204SBP	P43t (H4)	400832 <b>1856357</b>	12	100/90	1	100	7 <sup>P.116</sup>
62261SBP	PX26d (H7)	400832 <b>1856388</b>	12	80	1	100	8 <sup>P.116</sup>
69005SBP	P20d (HB3)	400832 <b>1888174</b>	12	100	1	100	22 <sup>P.116</sup>
69006SBP	P22d (HB4)	400832 <b>1888228</b>	12	80	1	100	24 <sup>P.116</sup>
64152SB	PX14.5s	4050300 <b>222738</b>	12	100	1	100	5 <sup>P.116</sup>
64153SB	PKY22s	4050300 <b>222837</b>	12	100	1	100	6 <sup>P.116</sup>
64198SB	P45t (R2)	4050300 <b>222028</b>	12	60/55	1	100	30 <sup>P.116</sup>

<sup>1)</sup> These products do not have ECE approval and must not be used on public roads in any exterior application. Public roads use leads to cancellation of operating license and loss of insurance coverage. Several countries forbid sale and use of these products. Please contact your local distributor for further information.



# XENARC® COOL BLUE® BOOST / COOL BLUE® BOOST

## Hyper white light for off-road use

The COOL BLUE® BOOST and XENARC® COOL BLUE® BOOST product families convince with hyper white light and high color temperatures. All lamps are designed and designated for off-road use only and not permitted on public roads<sup>1)</sup>.



### Features of

#### XENARC® COOL BLUE® BOOST<sup>1)</sup>

- Hyper white light for LED look
- Color temperatures of up to 7,000 K<sup>2)</sup>
- Enhanced brightness

### Features of

#### COOL BLUE® BOOST<sup>1)</sup>

- Hyper white light for LED look
- Color temperatures of up to 5,500 K<sup>2)</sup>
- Enhanced brightness

### Benefits of

#### XENARC® COOL BLUE® BOOST<sup>1)</sup> / COOL BLUE® BOOST<sup>1)</sup>

- Modern look
- High contrast
- More light allows to see farther and therefore react sooner



**OSRAM XENARC® COOL BLUE® BOOST high-performance headlamps<sup>1)</sup> – product range**

Product Reference		Product Number	V	W			
66140CBB-HCB	PK32d-2 (D1S)	4052899 <b>439184</b>	85	35	2	4	1 <sup>P.116</sup>
66240CBB-HCB	P32d-2 (D2S)	4052899 <b>441026</b>	85	35	2	4	3 <sup>P.116</sup>
66340CBB-HCB	PK32d-5 (D3S)	4052899 <b>527560</b>	42	35	2	4	1 <sup>P.116</sup>
66440CBB-HCB	P32d-5 (D4S)	4052899 <b>527522</b>	42	35	2	4	3 <sup>P.116</sup>

**OSRAM COOL BLUE® BOOST high-performance headlamps<sup>1)</sup> – product range**

Product Reference		Product Number	V	W			
62150CBB-HCB	P14.5s (H1)	4052899 <b>439764</b>	12	80	2	10	5 <sup>P.116</sup>
62193CBB-HCB	P43t (H4)	4052899 <b>439788</b>	12	100/90	2	10	7 <sup>P.116</sup>
62210CBB-HCB	PX26d (H7)	4052899 <b>439801</b>	12	80	2	10	8 <sup>P.116</sup>
62211CBB-HCB	PGJ19-2 (H11)	4052899 <b>439849</b>	12	75	2	10	14 <sup>P.116</sup>

1) These products do not have ECE approval and must not be used on public roads in any exterior application. Public roads use leads to cancellation of operating license and loss of insurance coverage. Several countries forbid sale and use of these products. Please contact your local distributor for further information.

2) Measured in headlamps



## Bringing light to life OSRAM LEDriving<sup>®</sup> fixtures

OSRAM has been turning night into day for over 110 years. With a history of pioneering technology and a future of ground-breaking innovations, you can rely on proven performance from the OSRAM LEDriving<sup>®</sup> products.

Driven by our striving for innovation and quality, we are redefining vehicle lighting from OSRAM. At OSRAM there is no compromise when it comes to quality and performance. A combination of individual design and innovative lighting technology meets high efficiency and effectiveness. OSRAM brings precise lighting to your vehicle and on the road.









# OSRAM LEDriving<sup>®</sup> headlights

## High efficiency meets extreme effectiveness



The OSRAM LEDriving<sup>®</sup> headlights bring precise lighting to the front of your vehicle and onto the road. The headlights are equipped with LED position light, LED low beam, LED high beam, LED daytime running light and dynamic LED indicator. Thanks to long-life high-performance LEDs with intensive brightness, they score with up to 200% more light<sup>1)</sup>, impress with up to 100% whiter light<sup>2)</sup> and are characterized by a lighting range that can reach up to 200 m. The OSRAM LEDriving<sup>®</sup> headlights are completely legal on public roads. Upgrading to the ECE-approved LEDriving<sup>®</sup> headlights complies with all legal requirements.

### Features

- OSRAM full LED head light:  
LED position light, LED low beam, LED high beam, LED daytime running light and dynamic LED turn indicator
- High-performance long-life LEDs
- State-of-the art diffuser material
- Up to 200% more light<sup>1)</sup>
- Up to 100% whiter light<sup>2)</sup>
- Up to 200 m long light beam
- Plug & Play installation
- ECE certified (ECE R6/R7/R48/R87/R112)
- IP protection class: IP69K

### Benefits

- Upgrade to the latest OEM premium technology
- Linear and homogeneous light distribution
- Pixel-free optics
- Improved view for the driver and more visibility of your vehicle by other road users, resulting in increased road safety
- Quick and uncomplicated installation without modifying or damaging existing cables
- Completely legal in road traffic
- Resistant to water, dust, cold and warm temperatures, UV light and permanent vibrations & shocks
- 2-year guarantee<sup>3)</sup>



**OSRAM LEDriving® headlights for VW Golf VII as halogen replacement – product range**

Product Reference	Product Number	V	W	K	l [mm]	w [mm]	h [mm]			
LEDHL103-GT <sup>4)5)</sup>	4052899 <b>599628</b>	12	-	6500	422	420	239	1	1	2 <sup>P.111</sup>
LEDHL103-CM <sup>4)5)</sup>	4052899 <b>599611</b>	12	-	6500	422	420	239	1	1	2 <sup>P.111</sup>
LEDHL103-CM RHD <sup>5)6)</sup>	4062172 <b>176026</b>	12	-	6500	422	420	239	1	1	2 <sup>P.111</sup>
LEDHL103-BK <sup>4)5)</sup>	4052899 <b>599598</b>	12	-	6500	422	420	239	1	1	2 <sup>P.111</sup>

**OSRAM LEDriving® headlights for VW Golf VII as xenon replacement – product range**

Product Reference	Product Number	V	W	K	l [mm]	w [mm]	h [mm]			
LEDHL104-GT <sup>4)5)</sup>	4052899 <b>604933</b>	12	-	6500	422	420	239	1	1	2 <sup>P.111</sup>
LEDHL104-CM <sup>4)5)</sup>	4052899 <b>604919</b>	12	-	6500	422	420	239	1	1	2 <sup>P.111</sup>
LEDHL104-BK <sup>4)5)</sup>	4052899 <b>604896</b>	12	-	6500	422	420	239	1	1	2 <sup>P.111</sup>



High Beam & Position Light



Low Beam & Position Light



Daytime Running Light



Position Light



Position Light & Indicator

- 1) Compared to minimum ECE R112 requirements
- 2) Compared to standard headlights with halogen lamp
- 3) Refer to [www.osram.com/am-guarantee](http://www.osram.com/am-guarantee) for precise conditions
- 4) Not suitable for left-hand traffic
- 5) Refer to [www.osram.com/am](http://www.osram.com/am) for detailed vehicle models
- 6) Suitable for left-hand traffic



VW Golf VII Facelift



VW Amarok

**OSRAM LEDriving® headlights for VW Golf VII Facelift as halogen replacement – product range**

Product Reference	Product Number	V	W	K	l [mm]	w [mm]	h [mm]			
LEDHL109-BK LHD <sup>(3)(4)</sup>	4062172 <b>169639</b>	12	-	6500	429	375	225	1	1	6 <sup>P.111</sup>
LEDHL109-GTI LHD <sup>(3)(4)</sup>	4062172 <b>169622</b>	12	-	6500	429	375	225	1	1	6 <sup>P.111</sup>



Position Light



Daytime Running Light



Low Beam & Position Light



Indicator

**OSRAM LEDriving® headlights for VW Amarok as halogen replacement – product range**

Product Reference	Product Number	V	W	K	l [mm]	w [mm]	h [mm]			
LEDHL107-BK <sup>(4)(5)</sup>	4052899 <b>616240</b>	12	-	6500	372	343	260	1	1	4 <sup>P.111</sup>
LEDHL107-BK RHD <sup>(5)(6)</sup>	4062172 <b>176033</b>	12	-	6500	372	343	260	1	1	4 <sup>P.111</sup>



High Beam & Position Light



Daytime Running Light



Low Beam & Position Light



Position Light & Indicator

- 1) Compared to minimum ECE R112 requirements
- 2) Compared to standard headlights with halogen lamp
- 3) Refer to [www.osram.com/am-guarantee](http://www.osram.com/am-guarantee) for precise conditions
- 4) Not suitable for left-hand traffic
- 5) Refer to [www.osram.com/am](http://www.osram.com/am) for detailed vehicle models
- 6) Suitable for left-hand traffic



**OSRAM LEDriving® headlights for BMW F20/21 as halogen replacement – product range**

Product Reference	Product Number	V	W	K	L [mm]	W [mm]	h [mm]			No.
LEDHL108-BK <sup>4)5)</sup>	4062172120333	12	-	6500	425	460	245	1	1	5 <sup>P.111</sup>
LEDHL108-CM <sup>4)5)</sup>	4062172120340	12	-	6500	425	460	245	1	1	5 <sup>P.111</sup>



Position Light



Daytime Running Light



Low Beam & Position Light

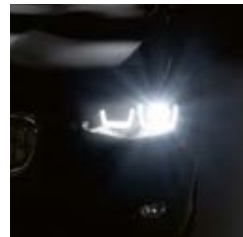

High Beam & Position Light



Indicator

- 1) Compared to minimum ECE R112 requirements
- 2) Compared to standard headlights with halogen lamp
- 3) Refer to [www.osram.com/am-guarantee](http://www.osram.com/am-guarantee) for precise conditions
- 4) Not suitable for left-hand traffic
- 5) Refer to [www.osram.com/am](http://www.osram.com/am) for detailed vehicle models

# OSRAM LEDriving® XENARC® headlights

## High efficiency meets extreme effectiveness

With its outstanding design, the LEDriving® XENARC® headlight combines modern LED daytime running light functionality with a powerful xenon lamp. With this headlight, OSRAM offers a solution for all VW Golf VI and Ford Focus 3 models not equipped with xenon headlights. Upgrading to the ECE-approved LEDriving® XENARC® headlight complies with all legal requirements – no need to fit automatic leveling or a headlight-cleaning system.



### Features of LEDriving® XENARC® headlight for VW Golf VI

- Up to 70% more light<sup>1)</sup>
- Up to 180 m long light beam
- Up to 40% whiter light<sup>2)</sup>
- Premium OSRAM quality available as GTI, BLACK and CHROME edition
- ECE certified with extra lifetime

### Features of LEDriving® XENARC® headlight for Ford Focus 3

- Up to 70% more light<sup>1)</sup>
- Up to 180 m long light beam
- Up to 40% whiter light<sup>2)</sup>
- Premium OSRAM quality
- ECE certified with extra lifetime

### Benefits of LEDriving® XENARC® headlight for VW Golf VI and for Ford Focus 3

- More light allows to see farther and therefore react sooner thanks to pixel-free optic and state-of-the-art lightguide technology
- Better visibility due to daylight effect with easy plug & play installation without modifying or damaging existing cables
- High contrast and brilliantly cool white LED light for the most stylish look on the road
- 2-year guarantee<sup>3)</sup>
- No additional beam level adjustment and headlight cleaning system required, as well as no additional parts and no registration needed for installation



**OSRAM LEDriving® XENARC® headlight for Ford Focus 3 – product range**

Product Reference	Product Number	V	W	K	l [mm]	w [mm]	h [mm]			No.
LEDHL105 <sup>4)5)</sup>	4052899 <b>600997</b>	12	70	6000	690	400	220	1	1	3 <sup>P.111</sup>



Daytime Running Light



Position Light and Low Beam



Position Light and High Beam



Position Light and Indicator

**OSRAM LEDriving® XENARC® headlight for VW Golf VI – product range**

Product Reference	Product Number	V	W	K	l [mm]	w [mm]	h [mm]			No.
LEDHL102-GT <sup>4)5)</sup>	4052899 <b>982178</b>	12	70	-	410	450	200	1	1	1 <sup>P.111</sup>
LEDHL102-CM <sup>4)5)</sup>	4052899 <b>982154</b>	12	70	-	410	450	200	1	1	1 <sup>P.111</sup>
LEDHL102-BK <sup>4)5)</sup>	4052899 <b>982130</b>	12	70	-	410	450	200	1	1	1 <sup>P.111</sup>
LEDHL102-BK RHD <sup>5)6)</sup>	4052899 <b>519411</b>	12	70	-	410	450	200	1	1	1 <sup>P.111</sup>



Daytime Running Light



Position Light and Low Beam



Position Light and High Beam



Position Light and Indicator  
(Dynamic/Static)

- 1) Compared to minimum ECE R112 requirements
- 2) Compared to standard headlights with halogen lamp
- 3) Refer to [www.osram.com/am-guarantee](http://www.osram.com/am-guarantee) for precise conditions
- 4) Not suitable for left-hand traffic
- 5) Only suitable for VW Golf VI and Ford Focus 3 cars with OEM halogen headlight
- 6) Suitable for left-hand traffic

ECE  
compliant

# OSRAM LEDriving<sup>®</sup> dynamic mirror indicators

## Individual design meets innovative lighting technology

The OSRAM LEDriving<sup>®</sup> dynamic mirror indicators offer an innovative design to impressively complement the individual look of your vehicle. They score, based on innovative high-performance LEDs, with up to 200% more brightness<sup>1)</sup> and impressive high contrast during day and night due to intensive yellow LED light<sup>2)</sup>. Thanks to the latest light guide technology, they also offer a homogeneous light distribution. As result of all these aspects, there is the possibility of an improved perception of your vehicle by oncoming traffic and consequently increased safety in road traffic. They are compatible with a variety of vehicle models and there are two variants to choose from: A black edition & a white edition. The OSRAM LEDriving<sup>®</sup> dynamic mirror indicators are completely legal on public roads. Upgrading to the ECE-approved LEDriving<sup>®</sup> dynamic mirror indicators complies with all legal requirements.

### Features

- Fully dynamic LEDriving<sup>®</sup> mirror indicator
- High-performance long-life LEDs
- Plug & Play Installation
- Black & White Edition
- ECE certified (ECE R6/R10)
- State-of-the-art light guide technology
- IP-Protection Class IP6K9K
- 5-year guarantee<sup>3)</sup>

### Benefits

- Up to 200% more brightness<sup>1)</sup>
- High contrast day and night due to intensive yellow LED light<sup>2)</sup>
- Improved visibility of your vehicle by other road users, resulting in increased road safety
- Quick and uncomplicated installation without modifying or damaging existing cables
- Tinted black design & clear white design
- Completely legal in road traffic
- Linear and homogeneous light distribution
- Resistant to water, dust, cold and warm temperatures, UV light and permanent vibrations & shocks



**OSRAM LEDDriving® Dynamic Mirror Indicator for VW Golf VII – product range**

Product Reference	Product Number	V	W	K	l [mm]	w [mm]	h [mm]			Light No.
LEDDMI 5G0 WT S <sup>4)</sup>	4062172046534	12	2.4	2700	280	70	50	1	4	7 <sup>P.111</sup>
LEDDMI 5G0 BK S <sup>4)</sup>	4062172046510	12	2.4	2700	280	70	50	1	4	7 <sup>P.111</sup>



**OSRAM LEDDriving® Dynamic Mirror Indicator for VW Golf VI – product range**

Product Reference	Product Number	V	W	K	l [mm]	w [mm]	h [mm]			Light No.
LEDDMI 5K0 WT S <sup>4)</sup>	4062172149105	12	4.9	2700	212	97	74	1	4	10 <sup>P.111</sup>
LEDDMI 5K0 BK S <sup>4)</sup>	4062172149082	12	4.9	2700	212	97	74	1	4	10 <sup>P.111</sup>



**OSRAM LEDDriving® Dynamic Mirror Indicator for VW Passat B8 – product range**

Product Reference	Product Number	V	W	K	l [mm]	w [mm]	h [mm]			Light No.
LEDDMI 3G0 WT S <sup>4)</sup>	4062172046497	12	2.4	2700	255	80	60	1	4	8 <sup>P.111</sup>



**Check the compatibility of your car!**  
 Vehicle Finder: [https://www.osram.com/am/dmi\\_vehiclefinder.jsp](https://www.osram.com/am/dmi_vehiclefinder.jsp)



1) Compared to the minimum ECE R6 requirements 2) Compared to other mirror indicators 3) Refer to [www.osram.com/am-guarantee](http://www.osram.com/am-guarantee) for precise conditions 4) For precise car models please refer to [www.osram.com/am](http://www.osram.com/am)



**OSRAM LEDDriving® Dynamic Mirror Indicator for BMW F20 – product range**

Product Reference	Product Number	V	W	K	l (mm)	w (mm)	h (mm)			Light No.
LEDDMI F20 WT S <sup>1)</sup>	4062172051286	12	4.56	2700	220	55	74	1	4	9 <sup>P.111</sup>
LEDDMI F20 BK S <sup>1)</sup>	4062172052795	12	4.56	2700	220	55	74	1	4	9 <sup>P.111</sup>



**OSRAM LEDDriving® Dynamic Mirror Indicator for Seat Leon 5F – product range**

Product Reference	Product Number	V	W	K	l (mm)	w (mm)	h (mm)			Light No.
LEDDMI 5F0 WT S <sup>1)</sup>	4062172052757	12	2.4	2700	237	54	50	1	4	13 <sup>P.111</sup>
LEDDMI 5F0 BK S <sup>1)</sup>	4062172052832	12	2.4	2700	237	54	50	1	4	13 <sup>P.111</sup>



1) For precise car models please refer to [www.osram.com/am](http://www.osram.com/am)



**OSRAM LEDDriving® Dynamic Mirror Indicator for Audi A4 B9 – product range**

Product Reference	Product Number	V	W	K	l (mm)	w (mm)	h (mm)			Light No.
LEDDMI 8W0 WT S <sup>1)</sup>	4062172052733	12	2.4	2700	255	65	69	1	4	11 <sup>P.111</sup>
LEDDMI 8W0 BK S <sup>1)</sup>	4062172052818	12	2.4	2700	255	65	69	1	4	11 <sup>P.111</sup>



**OSRAM LEDDriving® Dynamic Mirror Indicator for Audi A3 8V – product range**

Product Reference	Product Number	V	W	K	l (mm)	w (mm)	h (mm)			Light No.
LEDDMI 8V0 WT S <sup>1)</sup>	4062172052771	12	2.4	2700	242	56	70	1	4	12 <sup>P.111</sup>
LEDDMI 8V0 BK S <sup>1)</sup>	4062172052856	12	2.4	2700	242	56	70	1	4	12 <sup>P.111</sup>



1) For precise car models please refer to [www.osram.com/am](http://www.osram.com/am)



ECE  
compliant

## OSRAM LEDriving® tail lights

### Putting your car's rear out in front

The OSRAM LEDriving® tail lights bring precise lighting to the rear of your vehicle and onto the road. Thanks to long-life high-performance LEDs with intensive brightness, they score with up to 80% less energy consumption, impress with excellent homogeneity thanks to modern diffuser material and are characterized by precise light without delays. The OSRAM LEDriving® tail lights are completely legal on public roads. Upgrading to the ECE-approved LEDriving® tail lights complies with all legal requirements.

#### Features

- OSRAM LED-tail lights
- LED position light, LED stop light, LED dynamic turn indicator
- High-performance long-life LEDs
- State-of-the-art diffuser material
- Up to 80% less energy consumption<sup>1)</sup>
- No delayed response of the illumination
- Easy and quick plug & play installation
- IP Protection class: IP69K
- ECE certified (ECE R6/R7/R10/R23)
- 2-year guarantee<sup>2)</sup>

#### Benefits

- Upgrade to the latest OEM premium technology
- Excellent light distribution within the tail light
- Extremely high efficiency and effectiveness
- Improved visibility and therefore increased safety on the road
- No modification or damaging of existing cables
- Resistance to water, dust, vibration, shocks and hot & cold temperature
- No registration in the vehicle documents necessary

**OSRAM LEDriving® tail lights for VW Golf VI – product range**

Product Reference	Product Number	V	W	K	l [mm]	w [mm]	h [mm]			No.
LEDTL102-CL	4052899617001	12	30	-	480	205	280	1	1	15 <sup>P.111</sup>



Stop Light & Position Light



Position Light & Indicator



Rear Fog Light & Position Light



Position Light

**OSRAM LEDriving® tail lights for Ford Fiesta MK7 – product range**

Product Reference	Product Number	V	W	K	l [mm]	w [mm]	h [mm]			No.
LEDTL101-CL	4052899616257	12	27	-	361	254	400	1	1	14 <sup>P.111</sup>



Stop Light & Position Light



Position Light & Indicator



Position Light & Reverse Light



Position Light

1) Compared to standard tail lights with halogen lamp  
 2) Refer to [www.osram.com/am-guarantee](http://www.osram.com/am-guarantee) for precise conditions



# OSRAM LEDriving<sup>®</sup> driving lights

## Powerful performance and versatile applications

If the road and the surroundings are to be illuminated more intensively, the OSRAM LEDriving<sup>®</sup> driving lights facing this challenge with ease. Thanks to a variety of designs, shapes and light profiles, they convince with intense white LED light, at work or in the spare time, on dark country roads and forest paths, on-road and off-road for a powerful near- and far-field illumination.

### Features<sup>1)</sup>

- ECE-Certification
- High-performance long-life LEDs
- Up to 5,000h lifetime
- Shatterproof polycarbonate lens
- Integrated driver
- Integrated thermal management system
- Various shapes & beam patterns
- Highest IP-Protection Classes: IP67/IP69K

### Benefits<sup>1)</sup>

- No registration in the car documents required
- ECE-Certified
- Linear and homogeneous light distribution
- Improved view and visibility day & night resulting in increased safety
- Lightweight and at the same time robust and resistant
- Simple and reliable plug-in connection
- Protection against overheating
- Powerful far & near field illumination
- Resistant to extreme external influences regarding water, dust, impacts, heat & cold and permanent vibration & shocks

**Functional series product range – OSRAM LED driving lights**



Product Reference	Product Number	V	W	K	l [mm]	w [mm]	h [mm]			No.
LEDDL103-SP <sup>1)</sup>	4052899 <b>595330</b>	12/24	35	6000	309	93,5	54	1	4	18 <sup>P.111</sup>
LEDDL103-CB <sup>1)</sup>	4052899 <b>595354</b>	12/24	35	6000	309	93,5	54	1	4	18 <sup>P.111</sup>
LEDDL104-SP <sup>1)</sup>	4052899 <b>595378</b>	12/24	36	6000	564	93,5	54	1	4	19 <sup>P.111</sup>
LEDDL104-CB <sup>1)</sup>	4052899 <b>595392</b>	12/24	68	6000	564	93,5	54	1	4	19 <sup>P.111</sup>
LEDDL104-CB SM <sup>2)</sup>	4052899 <b>614079</b>	12/24	68	6000	564	93,5	54	1	4	19 <sup>P.111</sup>

**Slim series product range – OSRAM LED driving lights**



Product Reference	Product Number	V	W	K	l [mm]	w [mm]	h [mm]			No.
LEDDL105-SP <sup>1)</sup>	4052899 <b>595415</b>	12/24	14	6000	182	63,5	38	1	8	20 <sup>P.111</sup>
LEDDL106-SP <sup>1)</sup>	4052899 <b>595439</b>	12/24	29	6000	350	63,5	38	1	4	1 <sup>P.112</sup>
LEDDL106-CB <sup>1)</sup>	4062172 <b>142083</b>	12/24	29	6000	350	61,5	38	1	4	1 <sup>P.112</sup>
LEDDL107-SP <sup>1)</sup>	4052899 <b>595453</b>	12/24	46	6000	556	63,5	38	1	4	2 <sup>P.112</sup>
LEDDL107-CB <sup>1)</sup>	4062172 <b>142106</b>	12/24	44	6000	556	61,5	38	1	4	2 <sup>P.112</sup>

1) Special mounting regulations apply | 2) Single Mount (SM), does not need to be installed in pairs for 12/24 V-vehicles



**Multifunctional series product range – OSRAM LED driving lights**

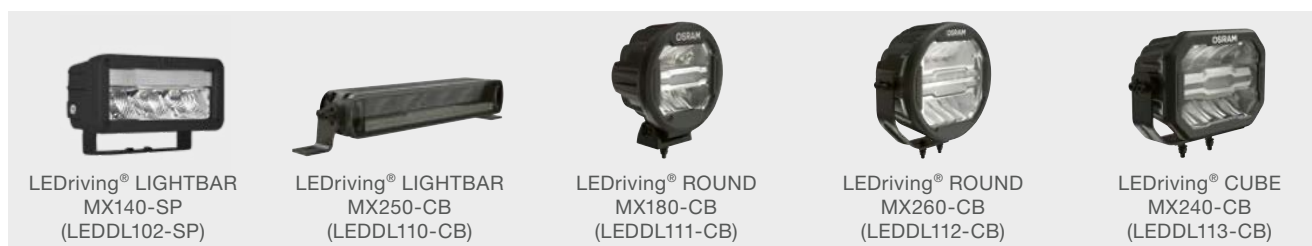

Product Reference	Product Number	V	W	K	l (mm)	w (mm)	h (mm)			No.
LEDDL102-SP <sup>1)</sup>	4052899 <b>595293</b>	12/24	30/2	6000	140	69,2	67	1	8	17 <sup>P.111</sup>
LEDDL110-CB <sup>1)</sup>	4062172 <b>153959</b>	12/24	45/1	6000	390	86	54	1	4	5 <sup>P.112</sup>
LEDDL111-CB <sup>1)</sup>	4062172 <b>153973</b>	12/24	39/1	6000	176	126	201	1	4	6 <sup>P.112</sup>
LEDDL112-CB <sup>1)</sup>	4062172 <b>153997</b>	12/24	60/2.5	6000	261	251	150	1	2	7 <sup>P.112</sup>
LEDDL113-CB <sup>1)</sup>	4062172 <b>154017</b>	12/24	70/1.5	6000	241	169	134	1	2	8 <sup>P.112</sup>



**Accessory series product range – OSRAM LED driving lights**

Product Reference	Product Number	V	W	K	l (mm)	w (mm)	h (mm)			No.
LEDDL ACC 101 <sup>1)</sup>	4062172 <b>147682</b>	12	-	-	-	-	-	1	8	15 <sup>P.112</sup>
LEDDL ACC 102 <sup>1)</sup>	4062172 <b>147729</b>	12	-	-	-	-	-	1	8	16 <sup>P.112</sup>
LEDDL ACC 103 <sup>1)</sup>	4062172 <b>147705</b>	12	-	-	686	71	93	1	6	17 <sup>P.112</sup>





**Value series product range – OSRAM LED driving lights**



Product Reference	Product Number	V	W	K	l (mm)	w (mm)	h (mm)			 No.
LEDDL115-SP <sup>1)</sup>	4062172 <b>141888</b>	12/24	27	6000	275	67	36	1	4	9 <sup>P.112</sup>
LEDDL116-SP <sup>1)</sup>	4062172 <b>141918</b>	12/24	63	6000	526	67	36	1	4	10 <sup>P.112</sup>
LEDDL117-CB <sup>1)</sup>	4062172 <b>141932</b>	12/24	30	6000	306	62	74	1	4	11 <sup>P.112</sup>
LEDDL118-CB <sup>1)</sup>	4062172 <b>141956</b>	12/24	55	6000	582	62	74	1	4	12 <sup>P.112</sup>
LEDDL119-WD <sup>1)</sup>	4062172 <b>150712</b>	12/24	22	6000	83	65	108	1	8	13 <sup>P.112</sup>
LEDDL120-CB SM <sup>1)</sup>	4062172 <b>232159</b>	12/24	108	6000	1031	67	35	1	4	14 <sup>P.112</sup>
LEDDL108-WD <sup>1)</sup>	4062172 <b>105712</b>	12/24	15	6000	121	48	131	1	8	3 <sup>P.112</sup>
LEDDL109-WD <sup>1)</sup>	4062172 <b>105736</b>	12/24	15	6000	113	56	127	1	8	4 <sup>P.112</sup>

1) Special mounting regulations apply



# OSRAM LEDriving<sup>®</sup> working lights

## Professional light for professional work

If the working environment and the surroundings are to be illuminated more intensively, the OSRAM LEDriving<sup>®</sup> working lights facing this challenge with ease. Thanks to a variety of designs, shapes and light profiles, they convince with intense white LED light, at work, on construction sites, agricultural activities, in forest operations and on off-road tracks, for a powerful near- and far-field illumination.

### Features

- High-performance long-life LEDs
- Up to 5,000 h lifetime
- Shatterproof polycarbonate lens
- Integrated driver
- Integrated thermal management system
- Powerful far & near field illumination
- Various beam angles
- Highest IP-Protection Classes: IP67/IP69K

### Benefits

- Linear and homogeneous light distribution
- Improved view and visibility day & night resulting in increased safety for you and others
- Lightweight and at the same time robust and resistant
- Simple and reliable plug-in connection
- Protection against overheating
- Powerful far & near field illumination
- Resistant to extreme external influences regarding water, dust, impacts, heat & cold and permanent vibration & shocks



**Multifunctional series product range – OSRAM LED working lights**



Product Reference	Product Number	V	W	K	l [mm]	w [mm]	h [mm]	Light No.	Light No.	Light No.
LEDDL101-SP	4052899 <b>595255</b>	12	22/2	6000	85	57	121,5	1	8	16 <sup>P.111</sup>
LEDDL101-WD	4052899 <b>595279</b>	12	22/2	6000	85	57	121,5	1	8	16 <sup>P.111</sup>
LEDDL102-WD	4052899 <b>595316</b>	12/24	30/2	6000	140	69,2	67	1	8	17 <sup>P.111</sup>

**Value series product range – OSRAM LED working lights**



Product Reference	Product Number	V	W	K	l [mm]	w [mm]	h [mm]	Light No.	Light No.	Light No.
LEDWL101-SP	4062172 <b>141970</b>	12/24	20	6000	80	70	85	2	16	18 <sup>P.112</sup>
LEDWL102-SP	4062172 <b>150699</b>	12/24	8	6000	75	30	93	2	16	19 <sup>P.112</sup>
LEDWL103-WD	4062172 <b>142021</b>	12/24	8	6000	73	31	97	2	16	20 <sup>P.113</sup>



# OSRAM LEDriving<sup>®</sup> daytime running lights

## Stylish highlights for state-of-the-art headlights

Innovative, easy-to-install lightguide and pixel solution with high-quality LED technology for low energy consumption and long lifetime: LEDriving<sup>®</sup> daytime running lights are the right choice for drivers who want to increase visibility during the day and with an eye for design.

### Features of LG (LEDDRL102)

- Lightguide technology for homogeneous light distribution
- LED daytime running light including position light
- Color temperatures of up to 6,000 K
- Premium OSRAM quality
- OEM technology with long lifetime of up to 5,000 h and low energy consumption

### Benefits of LG (LEDDRL102)

- Pixel-free brilliance and dynamic curves
- Dimmable light functions
- Perfect color match for existing HID and LED systems with cool white and stylish LED light
- 5-year guarantee<sup>1)</sup>
- Simple installation and compatible with start-stop system and hybrid vehicles

### Features of PX-5 (LEDDRL301 CL15)

- Faceted optic and dotted pixel technology
- LED daytime running light (ECE certified)
- Color temperatures of up to 5,200 K
- Premium OSRAM quality
- Long lifetime of up to 5,000 h with low energy consumption

### Benefits of PX-5 (LEDDRL301 CL15)

- Dynamic appearance of the daytime running lights
- Legal LED upgrade by improving both visibility and style
- Perfect color match for existing HID and LED systems with cool white and stylish LED light
- 3-year guarantee<sup>1)</sup>
- Simple installation



**OSRAM LEDDriving® daytime running light product range**

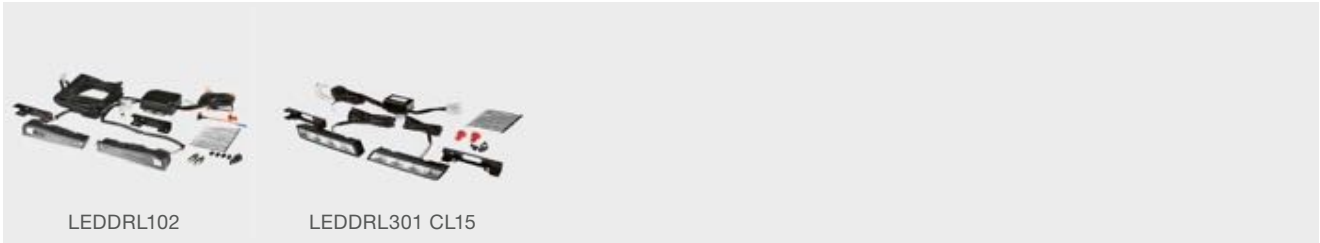

Product Reference	Product Number	V	W	K	l <sup>3)</sup> [mm]	w <sup>3)</sup> [mm]	h <sup>3)</sup> [mm]			 No.
LEDDR102 <sup>2)</sup>	4052899 <b>200494</b>	12	15	6000	167	42	32	1	4	21 <sup>P.113</sup>
LEDDR301 CL15 <sup>2)</sup>	4052899 <b>170766</b>	12	13.5	5200	160	30	23	1	5	22 <sup>P.113</sup>

1) Refer to [www.osram.com/am-guarantee](http://www.osram.com/am-guarantee) for precise conditions

2) Compatible with start-stop-system and hybrid vehicles

3) Product measurements





# OSRAM LEDambient®

## Stylish interior ambient lighting

The LEDambient® interior lights enable you to illuminate every single corner of your car. The high brightness of the products combined with the intense color temperatures puts your car into a new light. The LED strips are rapidly and easily mounted.

### Features of LEDambient® TUNING LIGHTS<sup>1)</sup>

- Flexible 16-color LED strips with adhesive backing
- Providing RGB styling to the interior of the vehicle
- 24-button wireless remote control
- OSRAM quality
- Adapter included for auto accessory plug-in

### Benefits of LEDambient® TUNING LIGHTS<sup>1)</sup>

- 4 flashing modes
- Dimmable
- Compact device for user-friendly operation
- 2-year guarantee<sup>2)</sup>
- Extension kit available

### Features of LEDambient® INTERIOR STRIP KIT<sup>1)</sup>

- High brightness thanks to 90 LEDs per 1.5 m strip
- White light with color temperature up to 4,500 K
- Two flexible self-adhesive LED strips of 1.5 m
- OSRAM quality
- Two strips per packaging, individually shortenable after every 3rd LED

### Benefits of LEDambient® INTERIOR STRIP KIT<sup>1)</sup>

- Illuminate every corner of your car, commercial vehicle or caravan
- Interior lighting for the vehicle roof, loading area, trunk or other cabinet lighting application
- Easy to install with no soldering or use of screws
- 2-year guarantee<sup>2)</sup>
- Individual length adjustment for various application purposes



**OSRAM LEDambient® TUNING LIGHTS product range**



Product Reference	Product Number	V	COLOR	KIT			No.
LEDINT201	4052899933576	12	Multicolor	Base Kit	1	2	-
LEDINT201-SEC	4052899248809	12	Multicolor	Base Kit	1	2	-
LEDINT202 <sup>3)</sup>	4052899933590	12	Multicolor	Extension Kit	1	2	-

**OSRAM LEDambient® INTERIOR STRIP KIT product range**

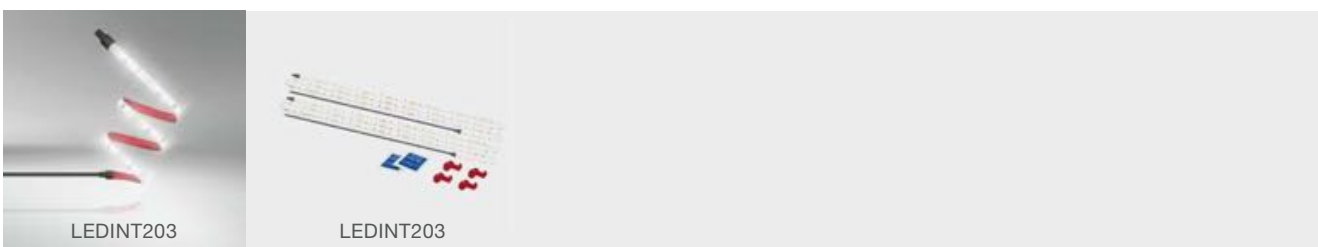

Product Reference	Product Number	V	COLOR	KIT			No.
LEDINT203	4052899516670	12	White color	-	1	2	23 <sup>P.113</sup>

1) These products do not have ECE approval and must not be used on public roads in any exterior application. Public roads use leads to cancellation of operating license and loss of insurance coverage. Several countries forbid sale and use of these products. Please contact your local distributor for further information.  
 2) Refer to [www.osram.com/am-guarantee](http://www.osram.com/am-guarantee) for precise conditions | 3) Only works in combination with the base kit



## LED ACCESSORIES

LED inspection lights, reading lights for vehicle interior and safety lights are mobile helpers with strong lumen output. These highly practical, mobile, and energy-efficient light sources are based on LED technology, enhanced by handy, ergonomic – and even elegant – designs to improve the daily work and life.





# OSRAM LEDinspect®

## Essential to your garage and beyond

The OSRAM LEDinspect® Inspection Lights, are tailored to a variety of individual requirements and needs. For a broad spectrum of tasks, challenges and areas of application, characterized by outstanding design, optimum product benefits and ideal product characteristics. These inspection lights are flexible, rotatable, rechargeable, adjustable, expandable, durable and much more. They include extraordinary features such as magnets, clips, hooks, rotating heads, adjustable and flexible elements, all housed in perfectly sized enclosures. They are dedicated for maintenance and repair work, for professional and private use, for mechanics, technicians, for car enthusiasts and much more.



### Features of FLOODER HELICOPTER (LEDIL HELI 1000)

- Luminance: 1,000 lm (high), 500 lm (low)
- 57 LEDs
- 10 Watt
- 6,000 K
- IP Protection Class IP44/IK06

### Benefits of FLOODER HELICOPTER (LEDIL HELI 1000)

- Multifunctional working light in extraordinary design
- Tripod length to be extended to 1.75m
- Multidirectional head
- Rotatable hook on bottom side
- Charging via Micro-USB (cable included)



### Features of FLOODER SPACESHIP (LEDIL SPACE 1000)

- Luminance: 1,000 lm (high), 500 lm (low)
- Side light: 500 lm (high), 250 lm (low)
- 36 LEDs (main light), 2x12 LEDs (side light)
- 20 Watt
- 6,000 K

### Benefits of FLOODER SPACESHIP (LEDIL SPACE 1000)

- Multidirectional lighting system
- Super flexible lighting system
- Use as floodlight, torch and spot-light
- Rotatable heads and adjustable light cone
- 2 removable side lights for various applications and individual allocation within the room and the working area





**Features of FLOODER 10W (LEDIL FLOOD 10W)**

- Luminance: 1,000 lm (high), 500 lm (low)
- 25 LEDs
- 10 Watt
- 6,000 K
- IP-Protection class: IP54, IK06

**Benefits of FLOODER 10W (LEDIL FLOOD 10W)**

- Small, compact and powerful floodlight
- Pleasant look and feel, easy to grip and dirt-resistant surface
- Easy portability
- Ideal as a work lamp for handi-craft activities, car repair, renovation and painting work
- Angle stand & magnets for hands free working and easy attachment



**Features of FLOODER 20W (LEDIL FLOOD 20W)**

- Luminance: 2,000 lm (high), 1,000 lm (low)
- 44 LEDs
- 20 Watt
- 6,000 K
- IP-Protection class: IP54, IK06

**Benefits of FLOODER 20W (LEDIL FLOOD 20W)**

- Small, compact and powerful floodlight
- Pleasant look and feel, easy to grip and dirt-resistant surface
- Easy portability
- Ideal as a work lamp for handi-craft activities, car repair, renovation and painting work
- Angle stand & magnets for hands free working and easy attachment



**Features of PROFESSIONAL 180 (LEDILPRO 180)**

- Luminance: 180 lm (high), 80 lm (low), 40 lm (torch)
- 16 LEDs (main light) 1 LED (torch)
- 6,000 K
- 3\* AAA alkaline battery (included)
- IP-Protection class: IP44, IK06

**Benefits of PROFESSIONAL 180 (LEDILPRO 180)**

- Compact & flexible design with powerful lighting
- Pleasant look and feel, easy to grip and dirt-resistant surface
- Ready to use immediately after purchase
- Provides optimal illumination for even the tightest of spaces and difficult-to-access areas
- Multi-positioning, magnet & hanging hook for hands free working



**Features of  
MINI COMPACT 80  
(LEDIL MN CP 80)**

- Luminance: 80 lm (high) , 30 lm (low), 40 lm (torch)
- 10 LEDs (main light) 1 LED (torch)
- 6,000 K
- 3\* AAA alkaline battery (included)
- IP-Protection class: IP44, IK06

**Benefits of  
MINI COMPACT 80  
(LEDIL MN CP 80)**

- Compact & flexible design with powerful lighting
- Pleasant look and feel, easy to grip and dirt-resistant surface
- Ready for use immediately after purchase
- Provides optimal illumination for even the tightest of spaces and difficult-to-access areas
- Multi-positioning, magnet & hanging hook for hands free working



**Features of  
PRO BONNET 1400 (LEDIL104)**

- Luminance: 1,400 lm
- Operable via 5 m cable and adjustable telescopic mounting bracket
- Protection class: IP65, IK06
- Premium OSRAM quality with ultra-slim design
- Long lifetime thanks to powerful long-lasting LEDs

**Benefits of  
BONNET 1400 (LEDIL104)**

- Excellent illumination for all types of professional inspection and maintenance
- Flexible working for mounting under the hood of the vehicle or with integrated hook
- Easy-to-grip and dirt-resistant surface
- 3-year guarantee<sup>1)</sup>
- More durability due to LED technology for a very long service life



**Features of  
MINI 125 (LEDIL202)**

- Luminance: 125 lm (high), 90 lm (low)
- Magnetic with hook and protection class: IP44, IK07
- Works with three AAA batteries (included)
- OSRAM quality in small and compact design with multifunctional features
- Increased lifetime thanks to long-lasting LEDs

**Benefits of  
MINI 125 (LEDIL202)**

- Ideal illumination for all types of inspection and maintenance
- Flexible mounting possibilities as well as dirt-resistant
- Immediate usage after purchase
- 2-year guarantee<sup>1)</sup>
- More durability due to LED technology for a long service life



**Features of  
PENLIGHT 80 (LEDIL203)**

- Luminance: 80 lm (high)
- Magnetic with clip and protection class: IP20, IK06
- Works with three AAA batteries (included)
- OSRAM quality in small and compact design with multifunctional features
- Increased lifetime thanks to long-lasting LEDs

**Benefits of  
PENLIGHT 80 (LEDIL203)**

- Ideal illumination for all types of inspection and maintenance
- Flexible mounting possibilities as well as dirt-resistant
- Immediate usage after purchase
- 2-year guarantee<sup>1)</sup>
- More durability due to LED technology for a long service life



**Features of  
HEADLAMP 300 (LEDIL209)**

- Luminance: 300 lm (100%), 60 lm (20%)
- Protection class: IP64, IK07
- Works with three AA batteries (included)
- Headlamp with 75% angle adjustment
- Increased lifetime thanks to long-lasting LEDs

**Benefits of  
HEADLAMP 300 (LEDIL209)**

- Multifunctional headlamp with zooming effect, flashing option and red warning light for higher visibility on the back
- Easy-to-grip and dirt-resistant surface
- Immediate usage after purchase for hand-free working thanks to head fixing (size adjustable)
- 2-year guarantee<sup>1)</sup>
- More durability due to LED technology for a long service life



**Features of  
MINI 250 (LEDIL401)**

- Luminance: up to 250 lm (high), 130 lm (low), 70 lm (torch)
- Multi angle positioning – 180° flex and protection class: IP65, IK07
- Magnetic base, back and hanging hook
- USB-C charging – charging plug and cable included

**Benefits of  
MINI 250 (LEDIL401)**

- Varying light output levels provide the right amount of light for the job
- Adjustable angles to give light where needed
- Pleasant look and feel, easy to grip and dirt-resistant surface
- Immediate usage after purchase
- See power status via battery charge indicator
- Durable and robust
- 2-year guarantee<sup>1)</sup>

1) Refer to [www.osram.com/am-guarantee](http://www.osram.com/am-guarantee) for precise conditions



**Features of  
MAX 500 (LEDIL402)**

- Luminance: up to 500 lm (high), 250 lm (low)
- Multi angle positioning – 180° flex & 360° twist and protection class: IP65, IK08
- UV-light function (1 LED + 1 UV LED)
- Magnetic base & back and hanging hook
- USB-C charging – charging plug and cable included

**Benefits of  
MAX 500 (LEDIL402)**

- UV torch for leak detection during vehicle inspection
- Varying light output levels provide the right amount of light for the job
- Pleasant look and feel, easy to grip and dirt-resistant surface
- Immediate usage after purchase
- See power status via battery charge indicator
- Durable and robust
- 2-year guarantee<sup>1)</sup>



**Features of  
SLIM 500 (LEDIL403)**

- Luminance: up to 500 lm (high), 250 lm (low), 70lm (torch)
- Multi angle positioning – 180° flex & 270° twist and protection class: IP54, IK07
- Magnetic base, hanging hook, foldable
- USB-C charging – charging plug and cable included

**Benefits of  
SLIM 500 (LEDIL403)**

- Ustable angles to give light where needed, extremely flexible in use
- Varying light output levels provide the right amount of light for the job
- Pleasant look and feel, easy to grip and dirt-resistant surface
- Immediate usage after purchase
- See power status via battery charge indicator
- Durable and robust
- 2-year guarantee<sup>1)</sup>



**Features of  
HEADTORCH 250 (LEDIL404)**

- Luminance: up to 250 lm (high), 140 lm (low)
- Multi angle positioning – 60° flex- and protection class: IP54, IK08
- Integrated motion sensor technology
- USB-C charging – charging plug and cable included

**Benefits of  
HEADTORCH 250 (LEDIL404)**

- Easily control light during hands free use thanks to motion sensor activation
- Provides comfort for hours of use thanks to soft pads and an adjustable harness
- Adjustable angles to give light where needed
- Varying light output levels provide the right amount of light for the job
- Immediate usage after purchase
- Durable and robust
- 2-year guarantee<sup>1)</sup>





**Features of**

**FAST CHARGE PRO 500 (LEDIL405)**

- Luminance: up to 500 lm (high), 100 lm (low), 100 lm (torch)
- Multi angle positioning – 180° flex and protection class: IP65, IK08
- Slim, compact, lightweight & foldable design
- Magnetic base & back and hanging hook
- USB-C charging – charging plug and cable included

**Benefits of**

**FAST CHARGE PRO 500 (LEDIL405)**

- Charges up to three times faster than a standard inspection lamp
- Varying light output levels provide the right amount of light for the job
- Pleasant look and feel, easy to grip and dirt-resistant surface
- Immediate usage after purchase
- See power status via battery charge indicator
- Durable and robust
- 2-year guarantee<sup>1)</sup>



**Features of**

**FAST CHARGE SLIM 500 (LEDIL406)**

- Luminance: up to 500 lm (high), 100 lm (low), 100 lm (torch)
- Multi angle positioning – 180° flex & 270° twist and protection class: IP54, IK08
- Slim and compact foldable design
- Magnetic base & back
- USB-C charging – charging plug and cable included

**Benefits of**

**FAST CHARGE SLIM 500 (LEDIL406)**

- Facilitates illumination in confined and hard to reach areas, perfect for on the go
- Adjustable beam angles for optimized illumination for different requirements
- Pleasant look and feel, easy to grip and dirt-resistant surface
- Immediate usage after purchase
- See the current charge status
- Durable and robust
- 2-year guarantee<sup>1)</sup>



**Features of**

**UTILITY 1000 (LEDIL407)**

- Luminance: up to 1,000 lm (high), 400 lm (low)
- Multi angle positioning – 180° flex & 360° twist and protection class: IP20, IK07
- Magnetic base and hanging hook
- 2x charging plugs and 2x cables included

**Benefits of**

**UTILITY 1000 (LEDIL407)**

- Super bright 1000 lm output allows for use in almost all environments
- Multi-functional – can be used hand held, flood lamp or under-bonnet lamp
- Varying light output levels provide the right amount of light for the job
- Immediate usage after purchase
- See power status via battery charge indicator
- Durable and robust
- 2-year guarantee<sup>1)</sup>

1) Refer to [www.osram.com/am-guarantee](http://www.osram.com/am-guarantee) for precise conditions





**Features of  
POCKET 200 (LEDIL408)**

- Luminance: up to 200 lm (high), 80 lm (low), 40 lm (torch)
- Multi angle positioning – 180° flex & 360° twist and protection class: IP20, IK07
- Slim, compact, lightweight & foldable design
- Magnetic base
- USB-C charging – charging plug and cable included

**Benefits of  
POCKET 200 (LEDIL408)**

- Facilitates illumination in confined and hard-to-reach areas, perfect for on-the-go
- Varying light output levels provide the right amount of light for the job
- Pleasant look and feel, easy to grip and dirt-resistant surface
- Immediate usage after purchase
- See power status via battery charge indicator
- Durable and robust
- 2-year guarantee<sup>1)</sup>



**Features of  
POCKET PRO 400 (LEDIL409)**

- Luminance: up to 400 lm (high), 100 lm (low), 100 lm (torch) + Dimming switch
- Multi angle positioning – 180° flex & 360° twist and protection class: IP40, IK06
- Slim, compact, lightweight & foldable design
- Magnetic base & back and hanging hook
- USB-C charging – charging plug and cable included

**Benefits of  
POCKET PRO 400 (LEDIL409)**

- Facilitates illumination in confined and hard-to-reach areas, perfect for on-the-go
- Varying light output levels provide the right amount of light for the job, dimming switch for individual light adjustment
- Pleasant look and feel, easy to grip and dirt-resistant surface
- Immediate usage after purchase
- See power status via battery charge indicator
- Durable and robust
- 2-year guarantee<sup>1)</sup>



**Features of  
SLIM MAX 1000 (LEDIL410)**

- Luminance: up to 1000 lm (high), 100 lm (low), 100 lm (torch)
- Multi angle positioning – 120° flex and protection class: IP65, IK06
- Integrated dimmer switch
- Magnetic base & back and hanging hook
- USB-C charging – charging plug and cable included

**Benefits of  
SLIM MAX 1000 (LEDIL410)**

- Super bright 1000 lm output allows for use in almost all environments
- Varying light output levels provide the right amount of light for the job
- Pleasant look and feel, easy to grip and dirt-resistant surface
- Immediate usage after purchase
- See power status via battery charge indicator
- Durable and robust
- 2-year guarantee<sup>1)</sup>

1) Refer to [www.osram.com/am-guarantee](http://www.osram.com/am-guarantee) for precise conditions



#### Features of POCKET-B200 (LEDIL411)

- Luminance: up to 200 lm (high), 80 lm (low), 40 lm (torch)
- Multi angle positioning – 180° flex & 360° twist and protection class: IP20, IK07
- Slim, compact, lightweight & foldable design
- Magnetic base
- 3 x AAA battery included

#### Benefits of POCKET-B200 (LEDIL411)

- Flexible and twistable, extremely adaptable inspection light, adjustable angles to give light where needed
- Varying light output levels provide the right amount of light for the job
- Pleasant look and feel, easy to grip and dirt-resistant surface
- Immediate usage after purchase
- Durable and robust
- 2-year guarantee<sup>1)</sup>





#### Features of TWIST 250 (LEDIL412)

- Luminance: up to 250 lm (high), 125 lm (low), 80 lm (torch)
- Multi angle positioning – 120° flex & 360° twist and protection class: IP20, IK09
- Magnetic base & back and hanging hook
- Charging plug and cable included

#### Benefits of TWIST 250 (LEDIL412)

- Flexible and twistable, extremely adaptable inspection light, adjustable angles to give light where needed
- Varying light output levels provide the right amount of light for the job
- Pleasant look and feel, easy to grip and dirt-resistant surface
- Immediate usage after purchase
- Durable and robust
- 2-year guarantee<sup>1)</sup>

### OSRAM LEDinspect® product range

Product Reference	Product Number	V	W	lm	K	l [mm] <sup>2)</sup>	w [mm] <sup>2)</sup>	h [mm] <sup>2)</sup>			 No.
LEDIL HELI 1000	4062172092241	3.7	12	1000/500	6000	392	136	136	1	4	1 <sup>P.114</sup>
LEDIL SPACE 1000	4062172092289	3.7	20	1000/500	6000	290	190	262	1	4	2 <sup>P.114</sup>
LEDIL FLOOD 10W	4062172092326	3.7	10	1000	6000	176	59	161	1	6	3 <sup>P.114</sup>
LEDIL FLOOD 20W	4062172092364	3.7	20	2000	6000	204	69	179	1	6	4 <sup>P.114</sup>
LEDIL PRO 180	4062172092302	4.5	2.2	180/40	6000	65	40	228	1	10	5 <sup>P.114</sup>
LEDIL MN CP 80	4062172092265	4.5	1.2	80/40	6000	66	31	129	1	10	6 <sup>P.114</sup>
LEDIL104	4052899970632	220	13-15	1.400	6000	1104	50	50	1	4	24 <sup>P.113</sup>
LEDIL202	4052899009578	4.5	1.6	125/90	8000	98	63	35	1	24	25 <sup>P.113</sup>
LEDIL203	4052899275607	4.5	1.6	80	7000	160	16	32	1	4	26 <sup>P.113</sup>
LEDIL209	4052899425033	4.5	5	300/60	7000	90	89	68	1	4	27 <sup>P.113</sup>
LEDIL401	4052899623828	3.7	7.4	250/130	6000	200	56	41	1	6	28 <sup>P.113</sup>
LEDIL402	4052899623835	3.7	16.5	500/250	6000	253	59	44	1	6	29 <sup>P.113</sup>
LEDIL403	4052899623842	3.7	9.62	500/250	6000	327	37	41	1	6	30 <sup>P.113</sup>
LEDIL404	4052899623859	3.7	5.55	300/60	5700	67	42	45	1	6	31 <sup>P.113</sup>
LEDIL405	4052899623866	3.7	9.25	500/100	5700	204	55	45	1	6	32 <sup>P.113</sup>
LEDIL406	4052899623873	3.7	9.25	500/100	5700	175	44	37	1	6	33 <sup>P.113</sup>
LEDIL407	4052899623880	7.4	19.24	1000/400	6500	500	50	48	1	6	34 <sup>P.113</sup>
LEDIL408	4052899623897	3.7	2.96	200/80	6500	233	29	43	1	6	35 <sup>P.113</sup>
LEDIL409	4052899622906	3.7	9.62	400/100	6000	215	100	55	1	6	36 <sup>P.113</sup>
LEDIL410	4052899622913	3.7	10	1000/100	6000	365	65	50	1	6	37 <sup>P.113</sup>
LEDIL411	4052899623927	3.7	2.96	200/80	6500	285	40	25	1	6	38 <sup>P.113</sup>
LEDIL412	4052899623934	3.7	8.14	250/125	6000	243	50	44	1	6	39 <sup>P.113</sup>

2) Product measurements

# OSRAM LEDguardian® warning lights

## Light is safety

See and be seen better – Be prepared for the rather extraordinary situations in road traffic with OSRAM. The orange, rotating or flashing warning light function of the entire product range is visible from a long distance and can provide crucial information about a dangerous or unusual situation in road traffic. For increased safety for you and others.



### Features of LEDguardian® ROAD FLARE<sup>1)</sup> (LED302)

- Multifunctional LED warning light with rotating amber light (two modes flashing & continuous-on) and white torch light
- Magnetic with protection class: IP20
- Works with three AAA batteries (included)
- OSRAM quality
- Increased lifetime thanks to long-lasting LEDs

### Benefits of LEDguardian® ROAD FLARE<sup>1)</sup> (LED302)

- See and be seen in emergency situations with up to 240 m distance
- Flexible mounting on various surfaces and crush-proof – doesn't break even when run over by a car<sup>2)</sup>
- Immediate usage after purchase
- 2-year guarantee<sup>3)</sup>
- More durability due to LED technology for a long service life



### Features of LEDguardian® SAVER LIGHT PLUS<sup>1)</sup> (LED101)

- Multifunctional LED warning light with two light functions (amber flashing and white torch light)
- Emergency light with seat-belt cutter and emergency hammer
- Magnetic with holder and protection class: IP44, IK07
- OSRAM quality
- Increased lifetime thanks to long-lasting LEDs
- Works with two AA batteries

### Benefits of LEDguardian® SAVER LIGHT PLUS<sup>1)</sup> (LED101)

- Be prepared for serious situations, thanks to high quality, long lasting LEDs
- Getting out by smashing the window or cutting the seat-belt
- Flexible mounting possibilities as well as dirt-resistant
- 2-year guarantee<sup>2)</sup>
- More durability due to LED technology for a long service life



**Features of LEDguardian® TRUCK FLARE SIGNAL TA19<sup>4)</sup> (LEDSSL103)**

- LED warning light + LED torch light
- Protection class: IP54, IK06
- Up to 6000 K
- Bright amber flashing light and bright white torch light
- Mandatory<sup>4)</sup> in Germany for vehicles  $\geq 3.5t$  recommended for other countries & vehicles  $\leq 3,5t$
- GGVS/ADR certified
- 4 x AA battery included

**Benefits of LEDguardian® TRUCK FLARE SIGNAL TA19<sup>1)</sup> (LEDSSL103)**

- Signals the position of the damaged, broken down etc. vehicle simply by positioning the truck flare next to the warning triangle
- Torch light allowing different product applications, such as the usage as a working or inspection light
- Water, dust and impact resistant
- Small, compact, lightweight and yet stable
- Non-slip, stable standing feet
- 2-year guarantee<sup>3)</sup>



**Features of LEDguardian® ROAD FLARE SIGNAL V16<sup>1)</sup> (LEDSSL102)**

- 140 lm light output & up to 1000m luminous range
- Protection class: IP54
- 360° flashing amber warning light
- V16 regulated
- CE certification
- Up to 2,000 K
- Stated in the General Vehicle Regulations in Spain & approved by Royal Decree
- High-performance long-life LEDs
- 1 x 9V battery included

**Benefits of LEDguardian® ROAD FLARE SIGNAL V16<sup>1)</sup> (LEDSSL102)**

- Signals the position of the damaged vehicle simply by pulling out the arm through the window to position it on the car
- Compact design for quick and easy attachment to the vehicle
- Ready to use immediately after purchase
- Insensitive to shocks and the ingress of dust and water
- Non-slip, dirt-repellent surface
- Small, compact, lightweight – easy and intuitive to use
- Due to the magnetic function the LED warning light can be conveniently attached to the car and other vehicles
- 2-year guarantee<sup>3)</sup>

1) Not approved as warning light according to German Road Traffic Licensing Regulations (StVZO). Not for sale in Germany.

2) Tested in a mid-range car at walking pace

3) Refer to [www.osram.com/am-guarantee](http://www.osram.com/am-guarantee) for precise conditions

4) Approved as warning light according to German Road Traffic Licensing Regulations (StVZO) §53a, §22a TA19 StVZO





**Features of LIGHTsignal LED (RBL102)**

- Up to 1200 lm
- Protection class: IP65, IK08
- 360° rotating beacon light
- 12V/24V compatible
- Certified in accordance with ECE R10 and R65
- Up to 1900 K
- Mounting method: 3 bolt fix
- 8 High-performance long-life LEDs
- Shock absorbing, fully rubberized base

**Benefits of LIGHTsignal LED (RBL102)**

- Improved visibility and thus increased safety for you and others
- Compact and modern design
- Mounting material included in scope of supply
- LEDs provide high luminosity by day and night
- Insensitive to shocks and the ingress of dust and water
- 2-year guarantee<sup>1)</sup>



**Features of LIGHTsignal HAL (RBL101)**

- Up to 1900 lm
- Protection class: IP65
- 360° rotating beacon light
- 24V compatible
- Certified in accordance with ECE R10 and R65
- Up to 2200 K
- Mounting method: 3 bolt fix

**Benefits of LIGHTsignal HAL (RBL101)**

- Improved visibility and thus increased safety for you and others
- Robust and functional design
- Mounting material included in scope of supply
- Optimum light output, bundling and distribution due to rotating unit consisting of highly polished parabolic reflector and H1 halogen lamp
- Insensitive to shocks and the ingress of dust and water
- 2-year guarantee<sup>1)</sup>





**OSRAM LEDguardian® ROAD FLARE**

Product Reference	Product Number	V	W	COLOR	l [mm] <sup>2)</sup>	w [mm] <sup>2)</sup>	h [mm] <sup>2)</sup>			No.
LEDSL302	4052899184053	4.5	0.5	Amber/White	110	42	-	1	24	7 <sup>P.114</sup>

**OSRAM LEDguardian® SAVER LIGHT PLUS**

Product Reference	Product Number	V	W	COLOR	l [mm] <sup>2)</sup>	w [mm] <sup>2)</sup>	h [mm] <sup>2)</sup>			No.
LEDSL101	4052899132344	3	1.7	Amber/White	180	63	53	1	6	8 <sup>P.114</sup>

**OSRAM LEDguardian® TRUCK FLARE Signal TA19**

Product Reference	Product Number	V	W	COLOR	l [mm] <sup>2)</sup>	w [mm] <sup>2)</sup>	h [mm] <sup>2)</sup>			No.
LEDSL103	4062172185967	6	3/1.5	Orange	90.7	42.6	236.5	1	10	9 <sup>P.114</sup>

**OSRAM LEDguardian® ROAD FLARE Signal V16**

Product Reference	Product Number	V	W	COLOR	l [mm] <sup>2)</sup>	w [mm] <sup>2)</sup>	h [mm] <sup>2)</sup>			No.
LEDSL102	4062172184359	9	6	Orange	83	83	57	1	20	10 <sup>P.114</sup>

**OSRAM LIGHTsignal LED**

Product Reference	Product Number	V	W	COLOR	l [mm] <sup>2)</sup>	w [mm] <sup>2)</sup>	h [mm] <sup>2)</sup>			No.
RBL102	4062172232258	12/24	7	Orange	89	89	148	1	12	11 <sup>P.114</sup>

**OSRAM LIGHTsignal HAL**

Product Reference	Product Number	V	W	COLOR	l [mm] <sup>2)</sup>	w [mm] <sup>2)</sup>	h [mm] <sup>2)</sup>			No.
RBL101	4062172192828	24	70	Orange	145	145	193	1	12	12 <sup>P.114</sup>

1) Refer to [www.osram.com/am-guarantee](http://www.osram.com/am-guarantee) for precise conditions

2) Product measurements

# OSRAM ONYX COPILOT®

## Good light for a good ride

OSRAM ONYX COPILOT® is a flexible LED reading light that emits a pleasantly warm, glare-free light. With an appealing black design, the ONYX COPILOT® is available in three versions: ONYX-USB with USB plug in, ONYX M+7 is powered via cigarette lighter, ONYX L+7 comes with a plastic base for fixed connection.



### Features

- Bright LED reading light for vehicle interior, 12 V & 24 V compatible
- Individual adjustment thanks to bendable neck
- Different plug-in ports (cigarette lighter, USB port, fix mounting) available
- Service life (LED): up to 20,000 h
- High protection class

### Benefits

- Pleasant warm and glare-free LED light
- Light can be switched on/off and remain connected permanently
- Provides simple installation
- 2-year guarantee<sup>1)</sup>
- Pleasantly look and feel, easy to grip and dirt-resistant surface

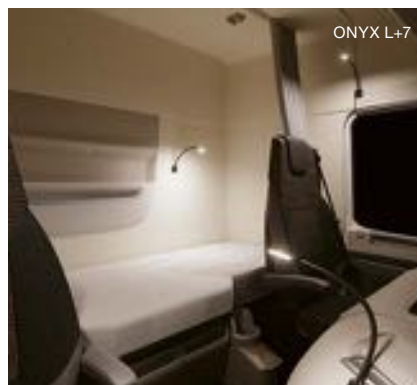



**OSRAM LED ONYX COPILOT® product range**



Product Reference	Product Number	V	W	lx	K	$\frac{l}{[mm]}$ <sup>3)</sup>	$\frac{w}{[mm]}$ <sup>3)</sup>	$\frac{h}{[mm]}$ <sup>3)</sup>				No.
ONYX-USB	4052899 <b>601000</b>	12/24	0.5	20	3000	370 <sup>2)</sup>	25	9	1	4		13 <sup>P.114</sup>
ONYX M+7	4052899 <b>07270</b>	12/24	0.5	20	3200	370 <sup>2)</sup>	25	9	1	4		14 <sup>P.114</sup>
ONYX L+7	4052899 <b>414938</b>	12/24	0.5	20	3200	370 <sup>2)</sup>	25	9	1	4		15 <sup>P.114</sup>

1) Refer to [www.osram.com/am-guarantee](http://www.osram.com/am-guarantee) for precise conditions

2) Not overall length of product

3) Product measurements



## Tools for all requirements – practical support in everyday life

As part of its holistic approach to products and marketing, OSRAM provides a large number of sets and tools to ensure the best possible support on the road and an attractive product presentation. Spare lamp kits make lamp replacement on the way possible. For retail outlets, filling stations and workshops practical lamp depots are available. High-quality displays and demonstration tools present and demonstrate products in a clear way, and with clear information. Your requirements are as unique as our OSRAM solutions.



**The shown presentation tools are illustrative. Please contact your responsible account manager if you are interested in our OSRAM Automotive polePOsition® and the new display designs.**



# OSRAM workshop helpers

## Practical at work and for the POS

The easy-to-use Shelf Rack provides space for the most important passenger car or truck lamps from OSRAM. The robust assortment box allows quick, mobile access to the most frequently required MINIWATT® lamps for passenger cars. Last but not least, the Automotive Lamp Cabinet offers clear and easy access to the OSRAM 12 V or 24 V product range.



### Main benefits of Automotive Lamp Cabinet

- Clear lamp arrangement
- Slot system for easy removal
- Drawers for additional lamps
- Lamp tester optionally available
- Available with or without lock

### Main benefits of Shelf Rack

- Row of hooks for presenting blister packs, DUO BOXES, new products
- Ideal for workshops and filling stations, practical for everyday use
- High-quality material and eye-catching design, ideal OSRAM in-store placement

### Main benefits of MINIWATT® 12 V assortment box

- 17 different MINIWATT® 12 V lamps for passenger cars (total of 180 lamps), highlighted in color
- Equipment overview with the most important technical data directly in the box

## OSRAM Automotive Lamp Cabinet | OSRAM Shelf Rack | OSRAM MINIWATT® 12 V

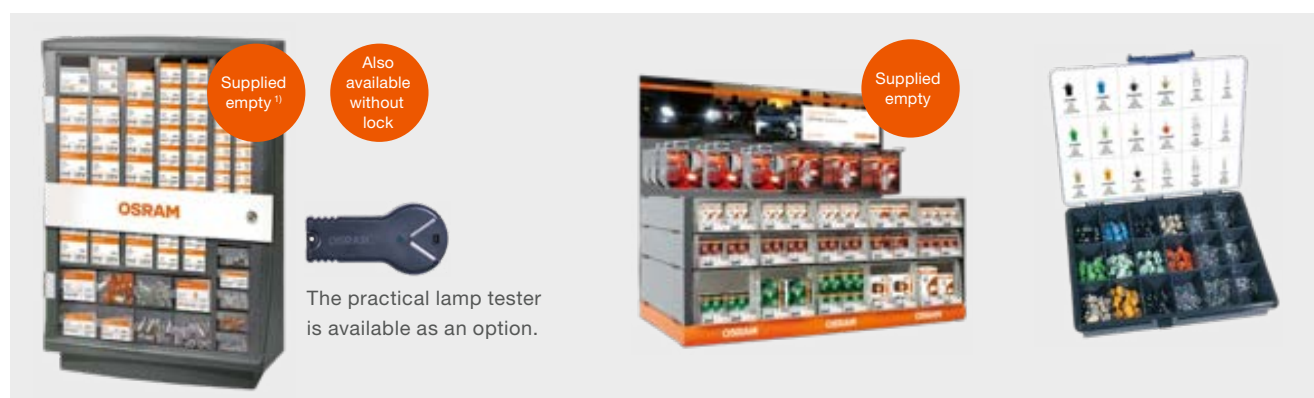

Product Reference	Product Number	Dimensions (W x H x D)	Contents	
ALC without <sup>1)</sup>	4008321694355	405 x 572 x 190 mm		
ALC with lock <sup>1)</sup>	4008321694362	405 x 572 x 190 mm		
Lamp tester 50X1	4008321786951	-		
SHELF RACK	4008321211248	920 x 900 x 580 mm		
509961	4008321082169	240 x 43 x 190 mm	180 lamps	3

<sup>1)</sup> We are happy to provide you with a proposal of stock. Please contact your local representative.



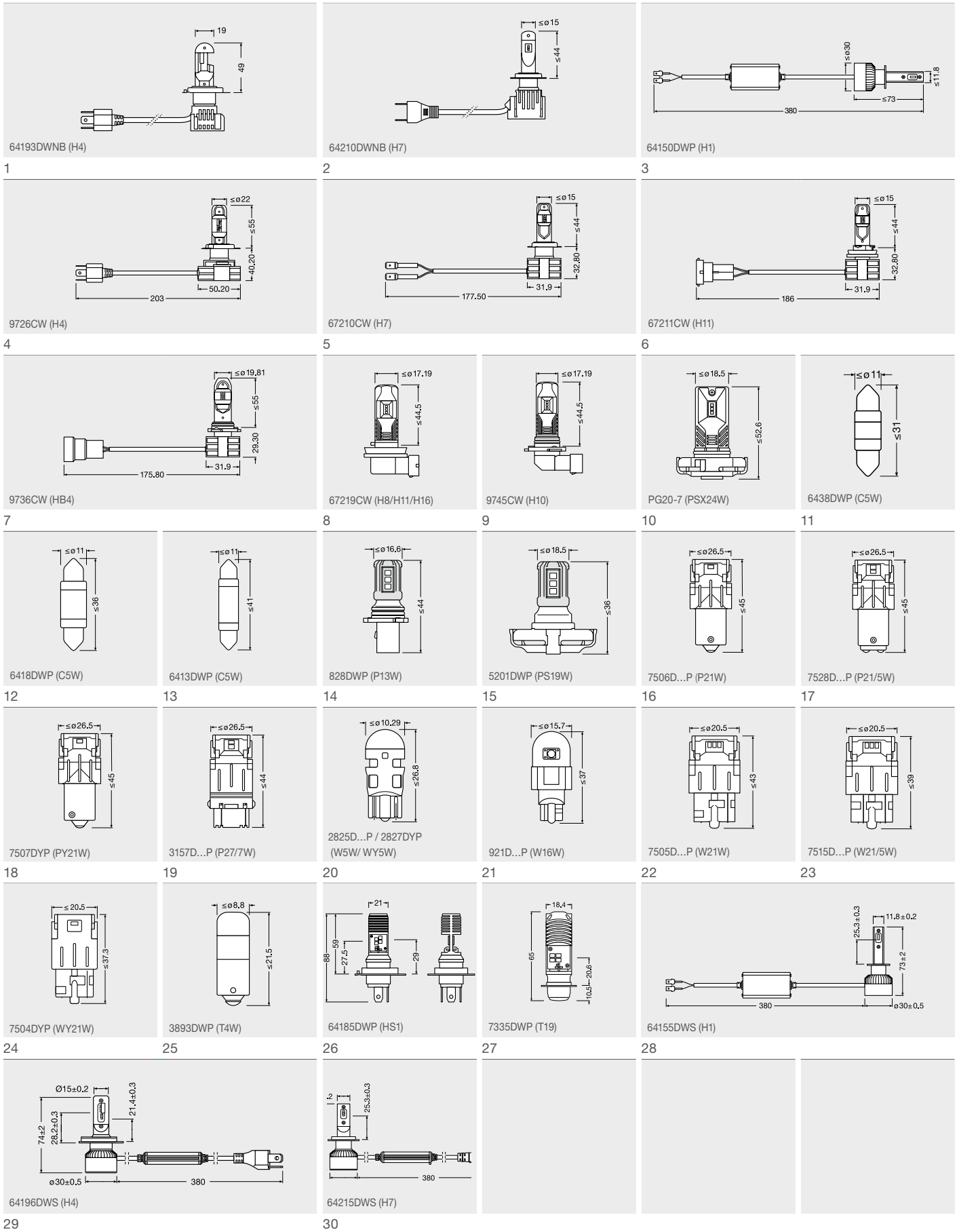

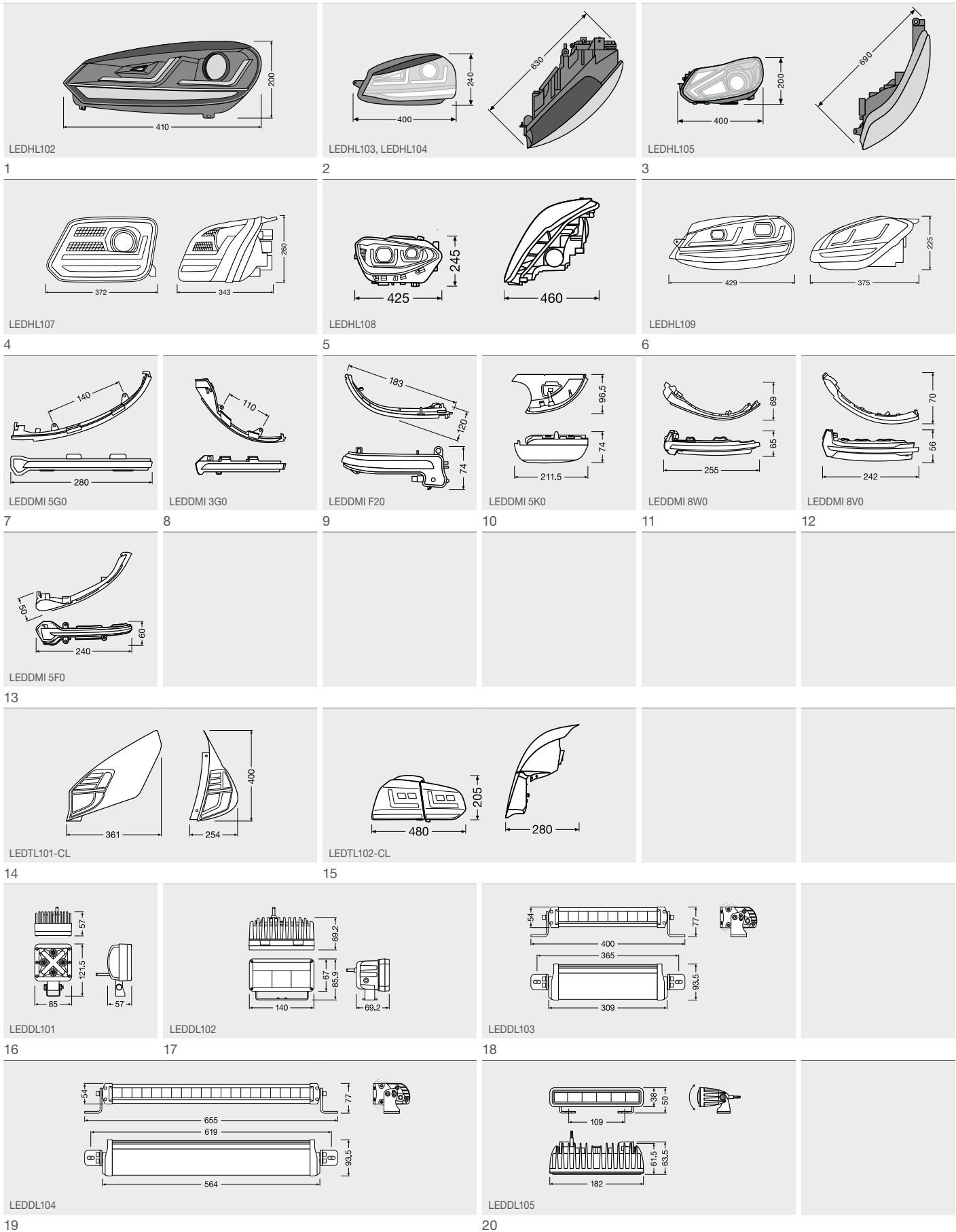

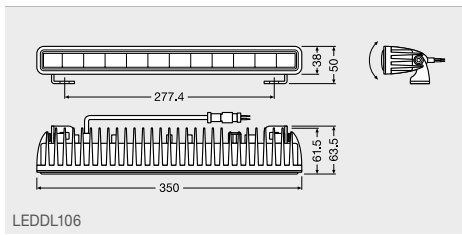

LEDDL106

1

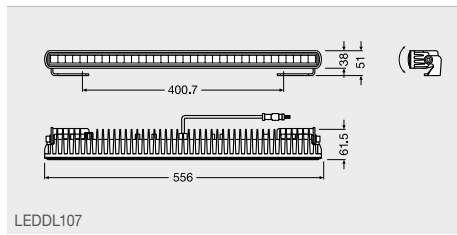

LEDDL107

2

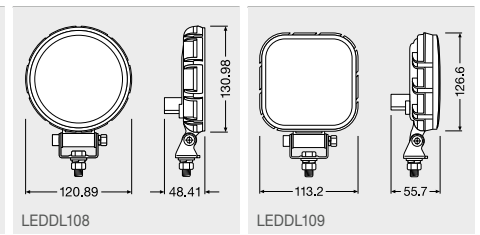

LEDDL108

LEDDL109

3

4

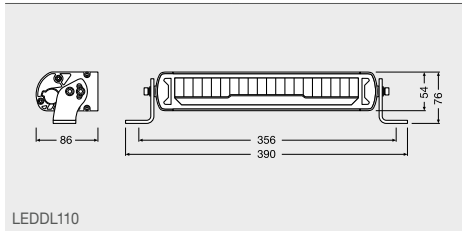

LEDDL110

5

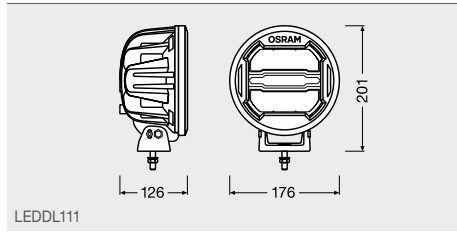

LEDDL111

6

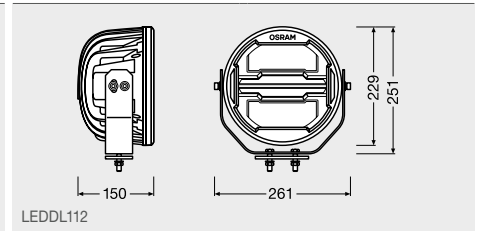

LEDDL112

7

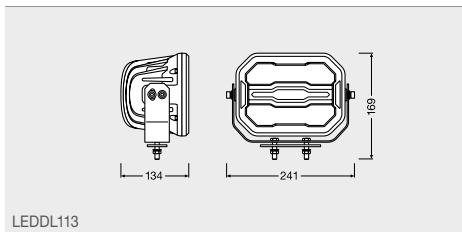

LEDDL113

8

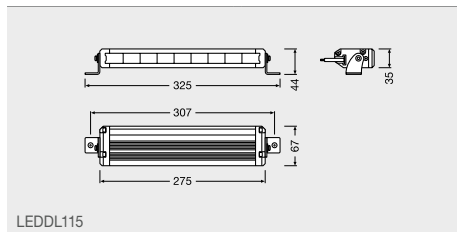

LEDDL115

9

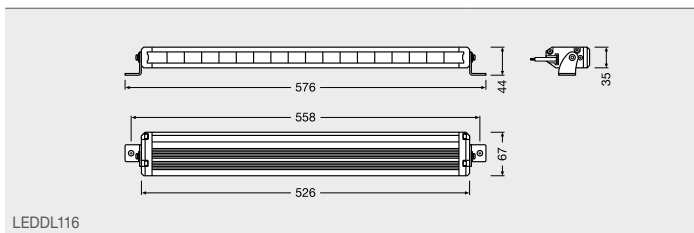

LEDDL116

10

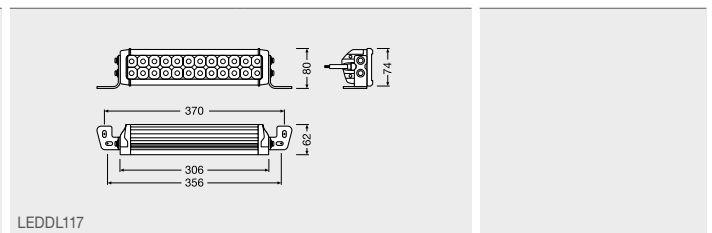

LEDDL117

11

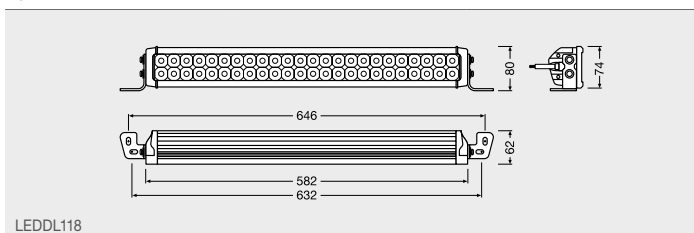

LEDDL118

12

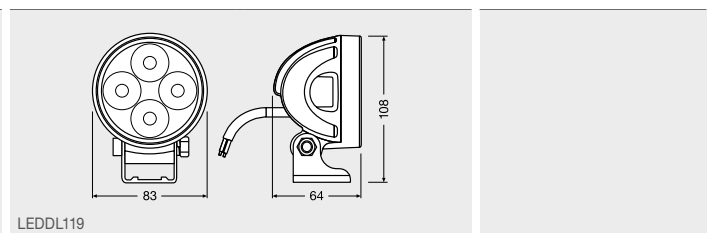

LEDDL119

13

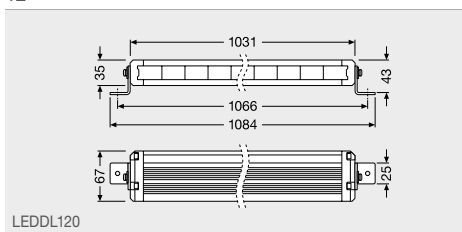

LEDDL120

14

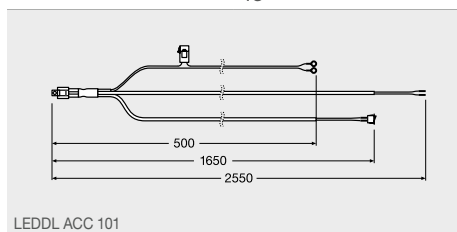

LEDDL ACC 101

15

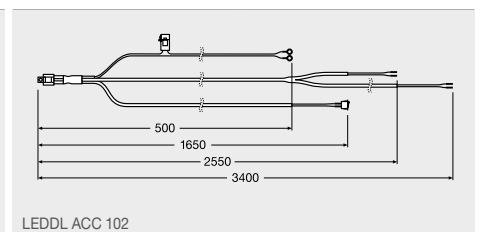

LEDDL ACC 102

16

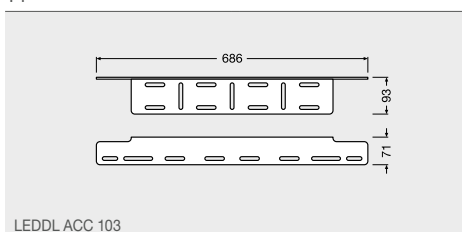

LEDDL ACC 103

17

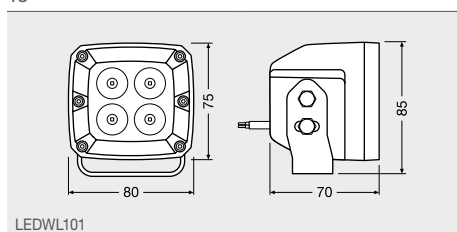

LEDWL101

18

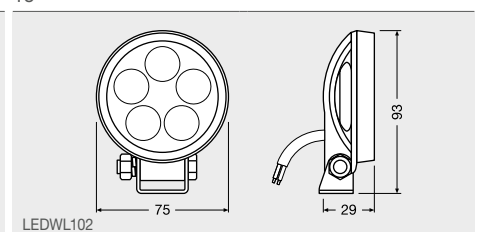

LEDWL102

19

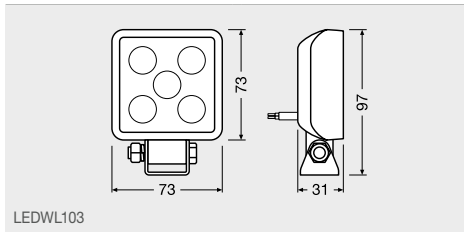

LEDWL103

20

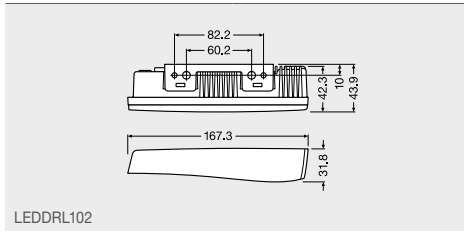

LEDDRL102

21

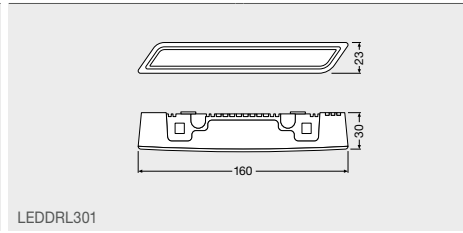
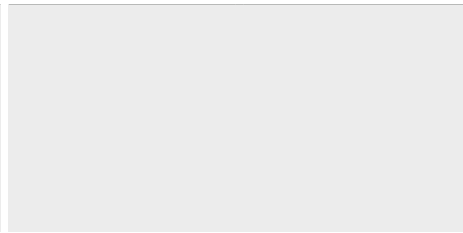

LEDDRL301

22

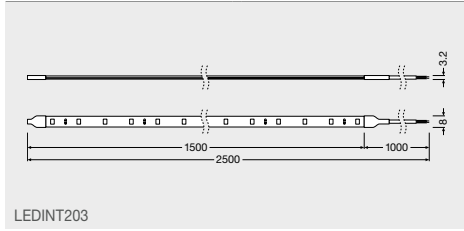

LEDINT203

23

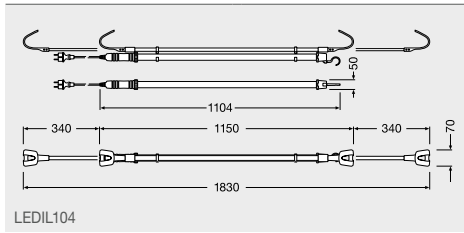

LEDIL104

24

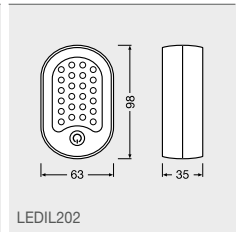
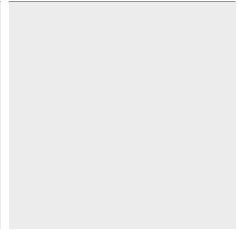

LEDIL202

25

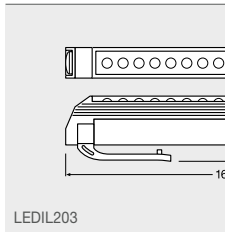
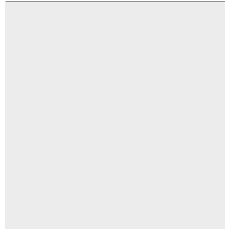

LEDIL203

26

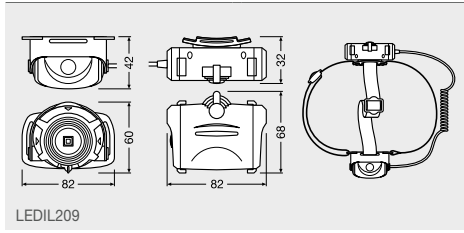

LEDIL209

27

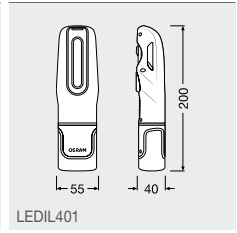

LEDIL401

28

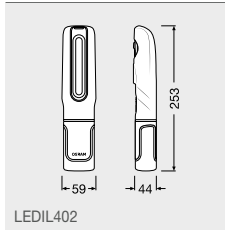

LEDIL402

29

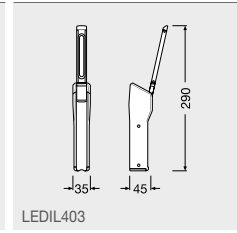

LEDIL403

30

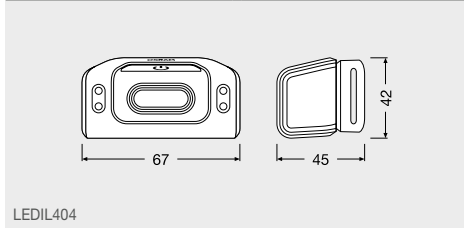

LEDIL404

31

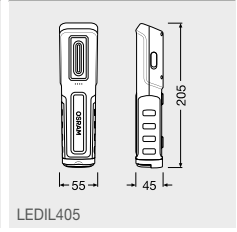

LEDIL405

32

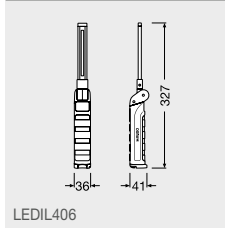

LEDIL406

33

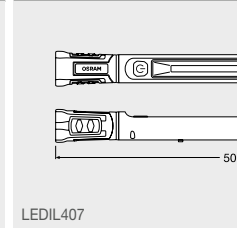

LEDIL407

34

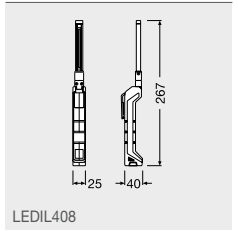

LEDIL408

35

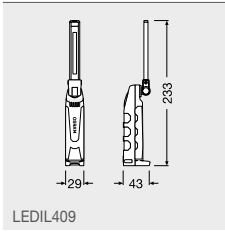

LEDIL409

36

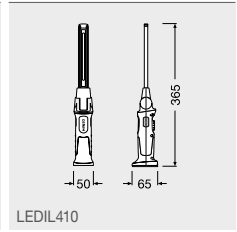

LEDIL410

37

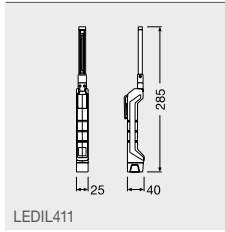

LEDIL411

38

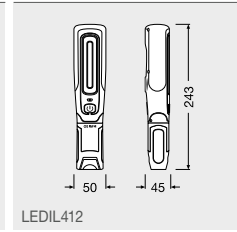

LEDIL412

39

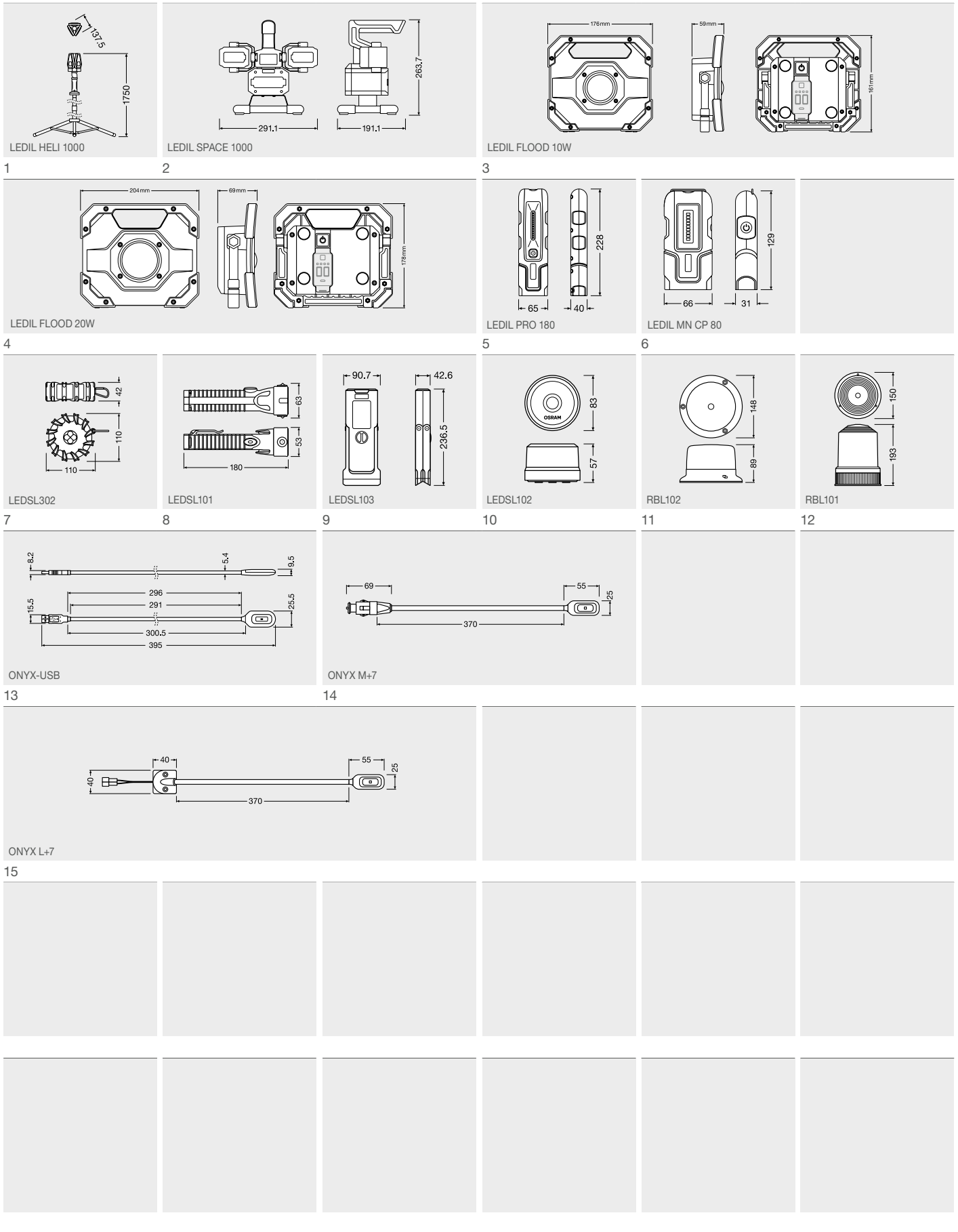



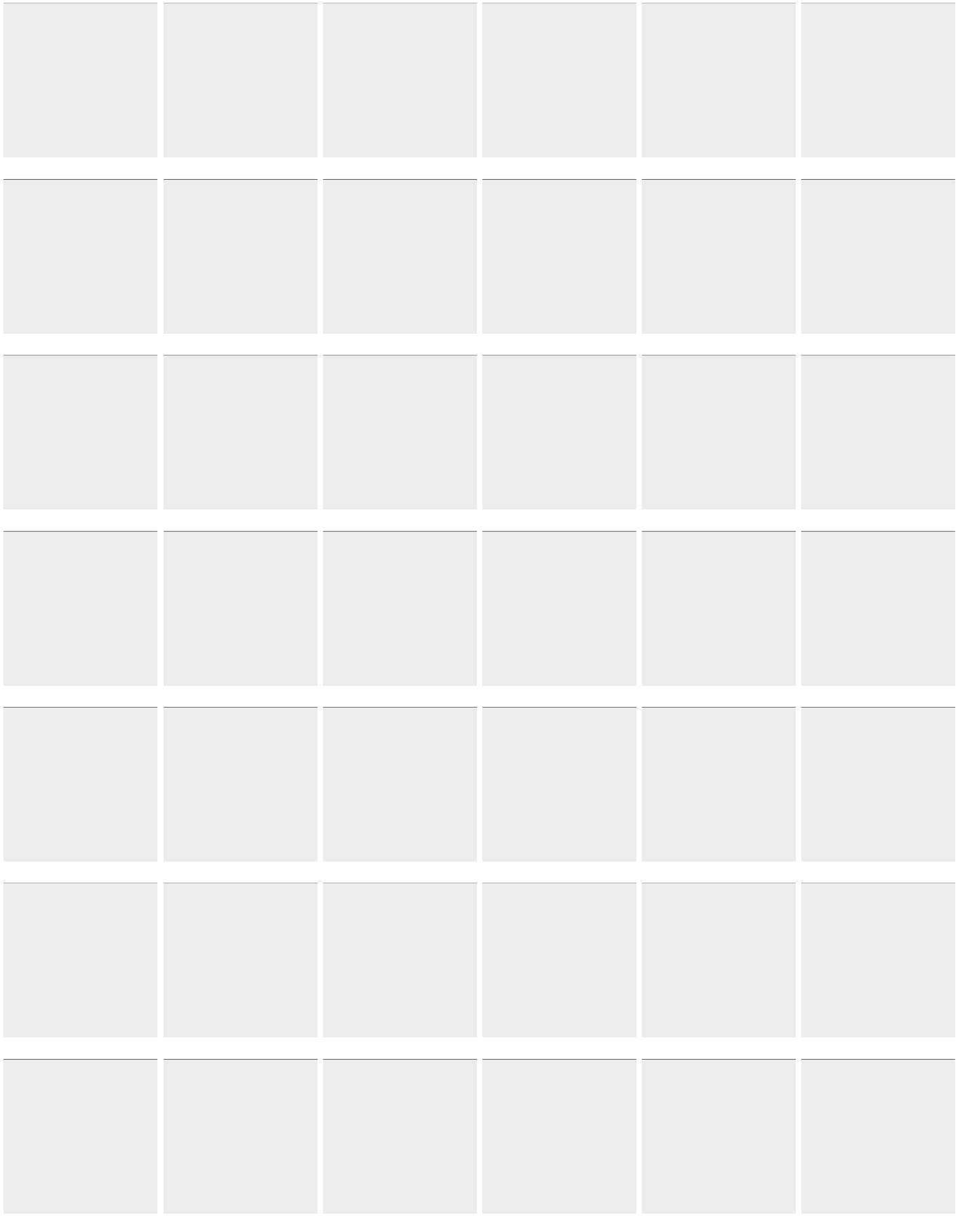

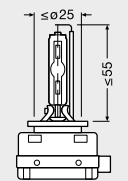
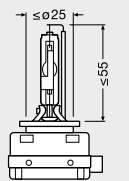
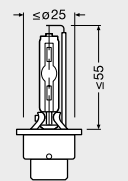
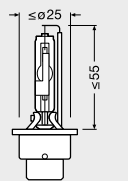
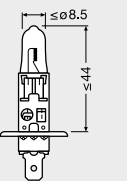
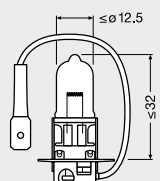
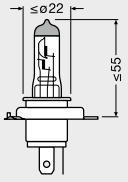
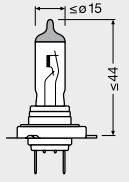
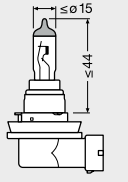
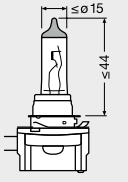
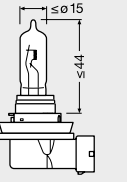
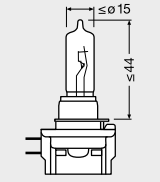
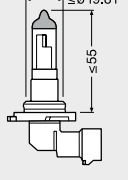
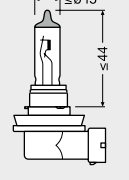
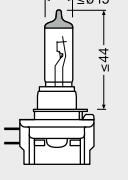
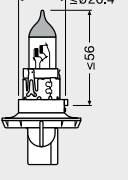
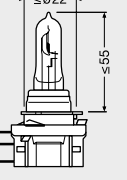
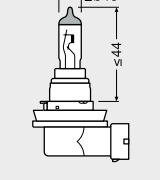
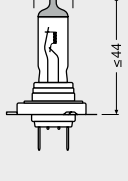
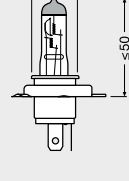
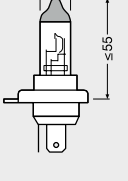
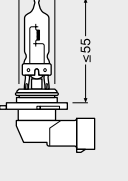
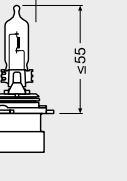
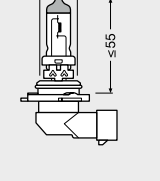
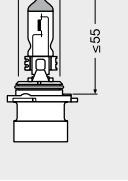
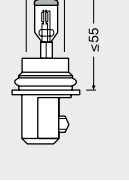
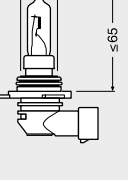
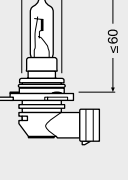
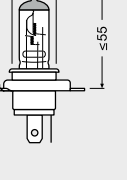
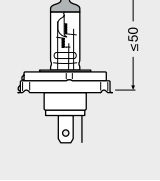
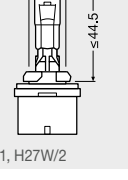
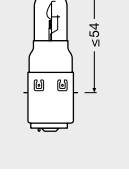
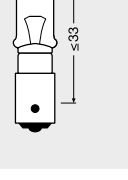
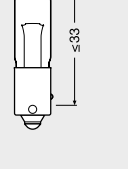
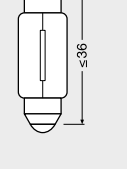
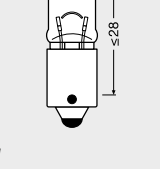
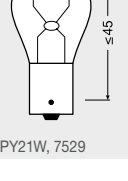
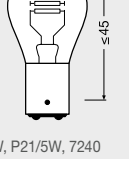
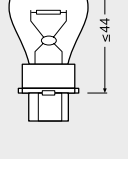
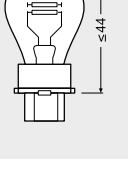
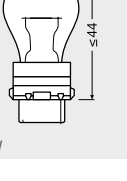
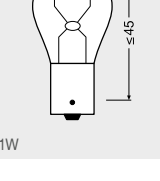

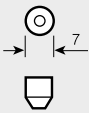
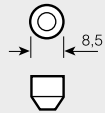
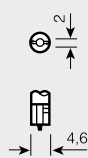

					
1	2	3	4	5	6
					
7	8	9	10	11	12
					
13	14	15	16	17	18
					
19	20	21	22	23	24
					
25	26	27	28	29	30
					
31	32	33	34	35	36
					
37	38	39	40	41	42

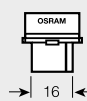
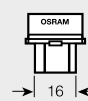
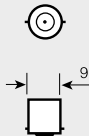
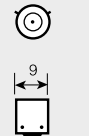
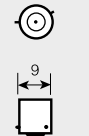

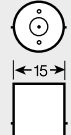
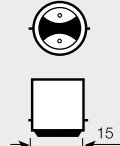
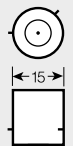
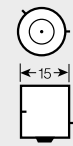
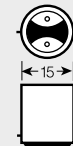
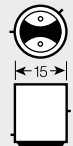
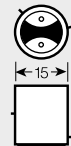
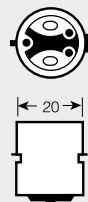
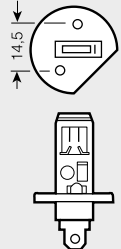
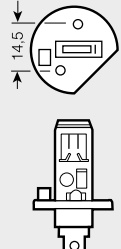
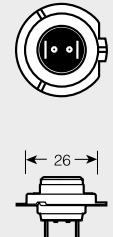
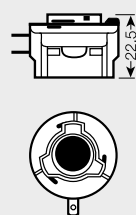
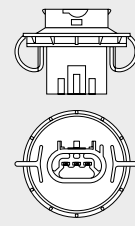
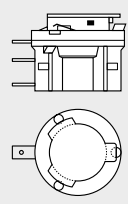
 PR21/5W	 PS19W	 PS24W	 PSX24W	 R5W, R10W, RY10W	 T4W, 3860
43	44	45	46	47	48
 W2.3W	 W3W, 2820	 W5W, WY5W, 2886X	 W16W	 WY16W	 W21W, WY21W
49	50	51	52	53	54
 W21/5W	 2341	 2721, 2722, 2741	 2840	 3796	 6411, 6413, 6421, 6424, 6429
55	56	57	58	59	60
 6428, 6430	 6438	 6461	 64111, 64113, 64115	 2351MFX6	 2352MFX6
61	62	63	64	65	66
 2452MFX6	 2473MFX6	 2721MF	 2721MFX	 2722MF	 2722MFX
67	68	69	70	71	72
 2741MF, 2741MFX	 828, 6851				
73	74				

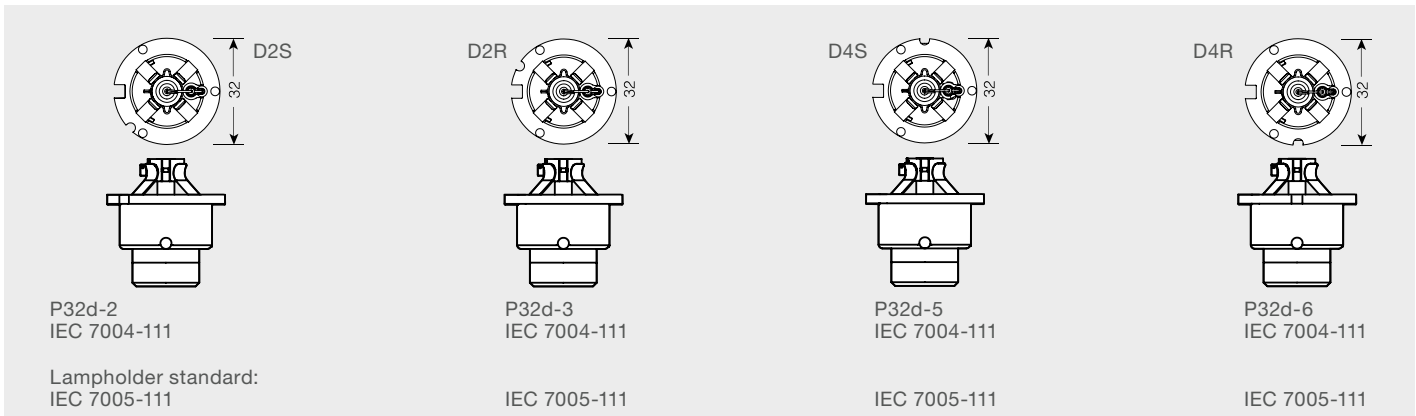
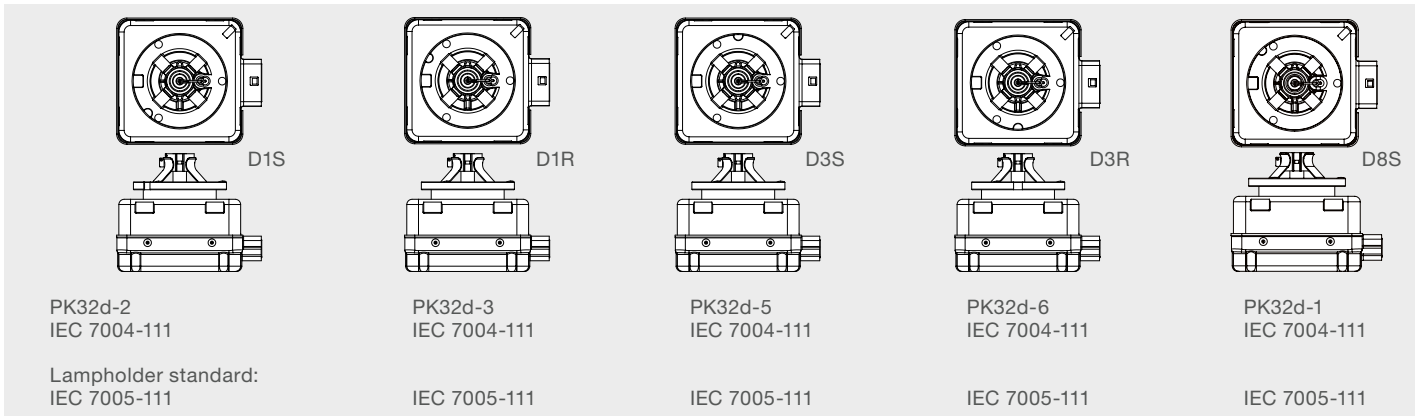
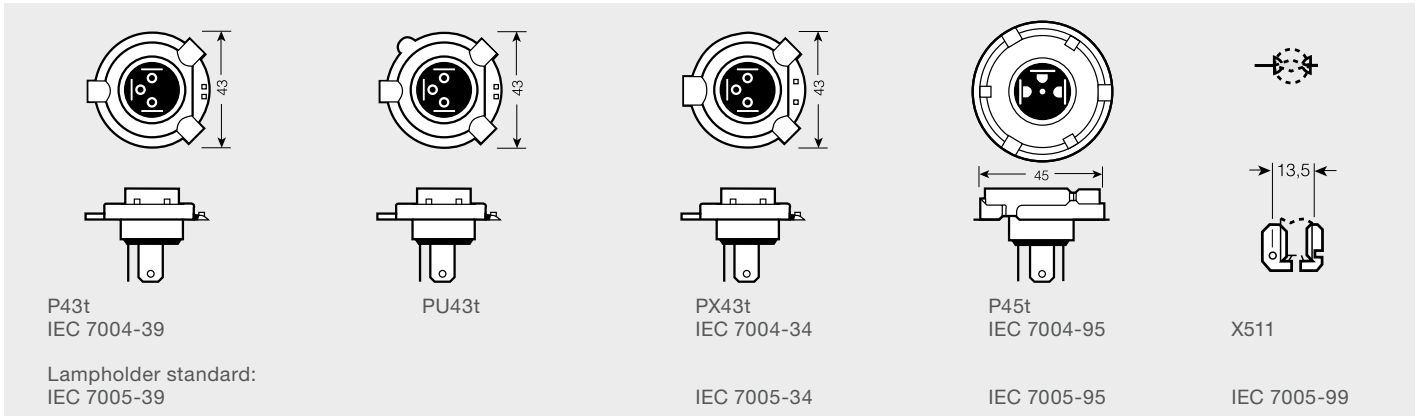
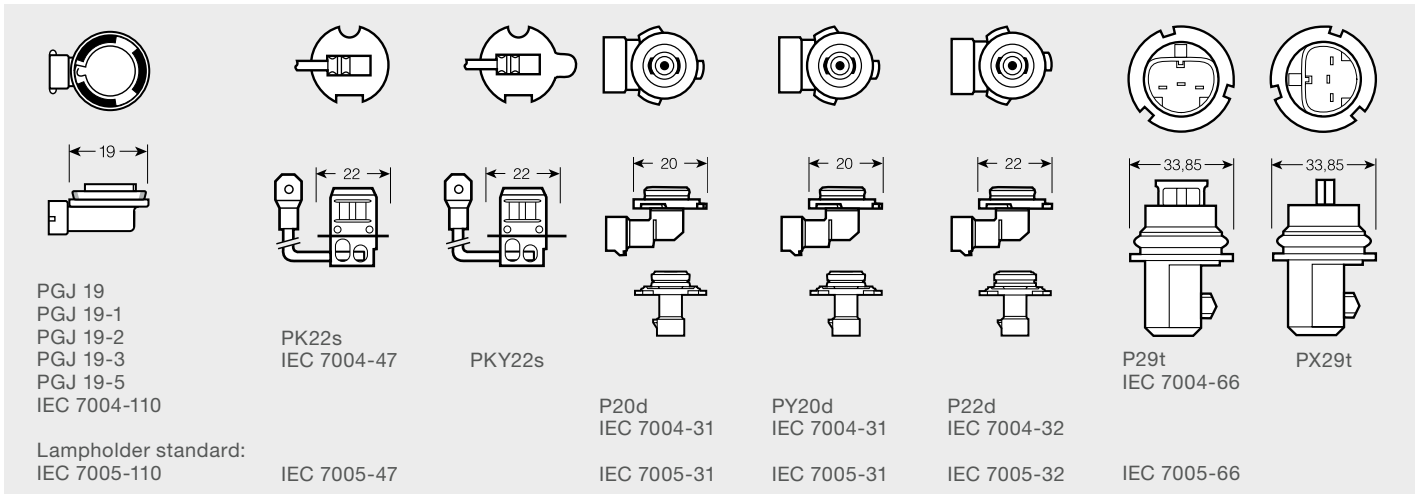
						
SV7-8 IEC 7004-80	SV8.5-8 IEC 7004-81	W2x4.6d IEC 7004-94	W2.1x9.5d IEC 7004-91	W2.5x16d IEC 7004-104	W2.5x16q IEC 7004-104	
Lampholder standard: IEC 7005-80	IEC 7005-80	IEC 7005-94	IEC 7005-91	IEC 7005-104	IEC 7005-104	
						
BA9s IEC 7004-14	BAY9s BAW9s IEC 7004-9	BAX9s IEC 7004-8	BX8.4d	B8.5d	BA15s IEC 7004-11A	BA15d IEC 7004-11A
Lampholder standard: IEC 7005-12	IEC 7005-9	IEC 7005-8	IEC 7005-140		IEC 7005-13	
						
BAU15s IEC 7004-19	BAW15s IEC 7004-11 E	BAY15d IEC 7004-11 B	BAZ15d IEC 7004-11 C	BAW15d IEC 7004-11 E	BA20d IEC 7004-12	
Lampholder standard: IEC 7005-13	IEC 7005-13	IEC 7005-13	IEC 7005-13	IEC 7005-13	IEC 7005-14	
						
P14.5s IEC 7004-46	PX14.5s	PX26d IEC 7004-5	PGJY19-2 PGJY19-5 PGJY19-1	P26.4t	PGJ23t-1	
Lampholder standard: IEC 7005-46		IEC 7005-5	IEC 7004-146 IEC 7005-146	IEC 7005-128	IEC 7004-155 IEC 7005-155	







# Type overview by ECE/SAE category

ECE	V	W		Product Reference		ECE	V	W		Product Reference	
-	12	-	-	LEDCAP01	P.24	-	12	13.5	-	LEDDL301 CL15	P.88
-	12	-	-	LEDCAP02	P.24	-	12	70	-	LEDHL102-BK	P.74
-	12	-	-	LEDCAP03	P.24	-	12	70	-	LEDHL102-BK RHD	P.74
-	12	-	-	LEDCAP04	P.24	-	12	70	-	LEDHL102-CM	P.74
-	12	5	-	LEDCBCTRL101	P.37	-	12	70	-	LEDHL102-GTI	P.74
-	12	21	-	LEDCBCTRL102	P.37	-	12	70	-	LEDHL103-GTI	P.70
-	12	50	-	LEDCBCTRL103	P.37	-	12	70	-	LEDHL103-BK	P.70
-	12	-	-	LEDDL ACC 101	P.84	-	12	70	-	LEDHL103-CM	P.70
-	12	-	-	LEDDL ACC 102	P.84	-	12	70	-	LEDHL103-CM RHD	P.70
-	12	-	-	LEDDL ACC 103	P.84	-	12	70	-	LEDHL104-GTI	P.70
-	12	22/2	-	LEDDL101-SP	P.86	-	12	70	-	LEDHL104-BK	P.70
-	12	22/2	-	LEDDL101-WD	P.86	-	12	70	-	LEDHL104-CM	P.70
-	12/24	30/2	-	LEDDL102-SP	P.84	-	12	70	-	LEDHL105	P.74
-	12/24	30/2	-	LEDDL102-WD	P.86	-	12	-	-	LEDHL107-BK	P.72
-	12/24	35	-	LEDDL103-SP	P.82	-	12	-	-	LEDHL107-BK RHD	P.72
-	12/24	35	-	LEDDL103-CB	P.82	-	12	-	-	LEDHL108-BK	P.73
-	12/24	36	-	LEDDL104-SP	P.82	-	12	-	-	LEDHL108-CM	P.73
-	12/24	68	-	LEDDL104-CB	P.82	-	12	-	-	LEDHL109-BK	P.72
-	12/24	68	-	LEDDL104-CB SM	P.82	-	12	-	-	LEDHL109-GTI	P.72
-	12/24	14	-	LEDDL105-SP	P.82	-	220	13-15	-	LEDIL104	P.96
-	12/24	29	-	LEDDL106-SP	P.82	-	4.5	1.6	-	LEDIL202	P.96
-	12/24	29	-	LEDDL106-CB	P.82	-	4.5	1.5	-	LEDIL203	P.97
-	12/24	46	-	LEDDL107-SP	P.82	-	4.5	3	-	LEDIL209	P.97
-	12/24	44	-	LEDDL107-CB	P.82	-	3.7	7.4	-	LEDIL401	P.97
-	12/24	15	-	LEDDL108-WD	P.85	-	3.7	16.5	-	LEDIL402	P.98
-	12/24	15	-	LEDDL109-WD	P.85	-	3.7	9.62	-	LEDIL403	P.98
-	12/24	45/1	-	LEDDL110-CB	P.84	-	3.7	5.55	-	LEDIL404	P.98
-	12/24	39/1	-	LEDDL111-CB	P.84	-	3.7	9.25	-	LEDIL405	P.99
-	12/24	60/2.5	-	LEDDL112-CB	P.84	-	3.7	9.25	-	LEDIL406	P.99
-	12/24	70/1.5	-	LEDDL113-CB	P.84	-	3.7	19.24	-	LEDIL407	P.99
-	12/24	27	-	LEDDL115-SP	P.85	-	3.7	2.96	-	LEDIL408	P.100
-	12/24	63	-	LEDDL116-SP	P.85	-	3.7	9.62	-	LEDIL409	P.100
-	12/24	30	-	LEDDL117-CB	P.85	-	3.7	10	-	LEDIL410	P.100
-	12/24	55	-	LEDDL118-CB	P.85	-	3.7	2.96	-	LEDIL411	P.101
-	12/24	22	-	LEDDL119-WD	P.85	-	3.7	8.14	-	LEDIL412	P.101
-	12/24	108	-	LEDDL120-CB SM	P.85	-	3.7	10	-	LEDIL HELI 1000	P.94
-	12/24	20	-	LEDWL101-SP	P.86	-	3.7	20	-	LEDIL SPACE 1000	P.94
-	12/24	8	-	LEDWL102-SP	P.86	-	3.7	10	-	LEDIL FLOOD 10W	P.95
-	12/24	8	-	LEDWL103-WD	P.86	-	3.7	20	-	LEDIL FLOOD 20W	P.95
-	12	2.4	-	LEDDMI 5G0 WT S	P.76	-	4.5	12	-	LEDIL PRO 180	P.95
-	12	2.4	-	LEDDMI 5G0 BK S	P.76	-	4.5	-	-	LEDIL MN CP 80	P.96
-	12	5.9	-	LEDDMI 5K0 WT S	P.76	-	12	-	-	LEDINT201	P.90
-	12	5.9	-	LEDDMI 5K0 BK S	P.76	-	12	-	-	LEDINT201-SEC	P.90
-	12	2.4	-	LEDDMI 3G0 WT S	P.76	-	12	-	-	LEDINT202	P.90
-	12	4.56	-	LEDDMI F20 WT S	P.78	-	12	-	-	LEDINT203	P.90
-	12	4.56	-	LEDDMI F20 BK S	P.78	-	12	-	-	LEDSC01-2HFB	P.37
-	12	2.4	-	LEDDMI 5F0 WT S	P.78	-	12	-	-	LEDSC01-2HFB	P.24
-	12	2.4	-	LEDDMI 5F0 BK S	P.78	-	12	-	-	LEDSC02-1-2HFB	P.24
-	12	2.4	-	LEDDMI 8W0 WT S	P.79	-	12	-	-	LEDSC03-2HFB	P.24
-	12	2.4	-	LEDDMI 8W0 BK S	P.79	-	12	-	-	LEDSC03-1-2HFB	P.24
-	12	2.4	-	LEDDMI 8V0 WT S	P.79	-	3	1.7	-	LEDHL101	P.102
-	12	2.4	-	LEDDMI 8V0 BK S	P.79	-	9	6	-	LEDHL102	P.103
-	12	15	-	LEDDL102	P.88	-	6	3/1.5	-	LEDHL103	P.103

ECE	V	W		Product Reference	
-	4.5	0.5	-	LED3L302	P.102
-	12	30	-	LEDTL102-CL	P.80
-	12	27	-	LEDTL101-CL	P.80
-	12/24	0.5	-	ONYX L+7	P.106
-	12/24	0.5	-	ONYX M+7	P.106
-	12/24	0.5	-	ONYX USB	P.106
-	12/24	7	-	RBL102	P.104
-	24	70	-	RBL101	P.104
-	12	1.6	PG18.5d-1	828DWP <sup>1)</sup>	P.30
-	12	2.1	W2.1x9.5d	921DWP <sup>1)</sup>	P.30
-	12	1.4	W2.1x9.5d	921DRP <sup>1)</sup>	P.30
-	12	1.2	BX8.4d	2351MFX6	P.54
-	12	2	BX8.4d	2352MFX6	P.54
-	12	1.5	BX8.4d	2452MFX6	P.54
-	12	1.12	BX8.4d	2473MFX6	P.54
-	12	6.7	PG20-7	2604CW	P.28
-	12	1.2	W2x4.6d	2721	P.53
-	12	1.2	B8.5d	2721MF	P.54
-	12	1.2	BX8.5d	2721MFX	P.54
-	12	2	W2x4.6d	2722	P.54
-	12	2	B8.5d	2722MF	P.54
-	12	2	BX8.5d	2722MFX	P.54
-	12	0.25	W2x4.6d	2723DWP <sup>1)</sup>	P.30
-	12	2	W2.1x9.5d	2820	P.53
-	12	0.8	W2.1x9.5d	2825DWP <sup>1)</sup>	P.30
-	12	0.6	W2.1x9.5d	2825DRP <sup>1)</sup>	P.30
-	12	1	W2.1x9.5d	2827DYP <sup>1)</sup>	P.30
-	12	6	W2.1x9.5d	2886X	P.49
-	12	2.0	W3x16q	3157DWP <sup>1)</sup>	P.30
-	12	1.4	W3x16q	3157DRP <sup>1)</sup>	P.30
-	12	1.3	W3x16q	3157DYP <sup>1)</sup>	P.30
-	12	2	BA9s	3796	P.54
-	12	5	BA9s	3860	P.53
-	12	0.8	BA9s	3893DWP <sup>1)</sup>	P.30
-	12	0.5	BA15s	5007DWP <sup>1)</sup>	P.30
-	12	1.2	BA15s	5008DWP <sup>1)</sup>	P.30
-	12	1.6	PG20-1	5201DWP	P.30
-	12	10	SV8.5-8	6411	P.54
-	12	5	SV8.5-8	6413	P.54
-	12	0.6	SV8.5-8	6413DWP <sup>1)</sup>	P.30
-	12	0.6	SV8.5-8	6418DWP <sup>1)</sup>	P.30
-	12	3	SV7-8	6428	P.54
-	12	10	SV8.5-8	6438	P.54
-	12	1.0	SV8.5-8	6438DWP <sup>1)</sup>	P.30
-	12	10	SV8.5-8	6461	P.54
-	12	6	SV8.5-8	6486X	P.54
-	12	21/5	BA15d	7240	P.53
-	12	5/5	P15d-25-1	7335DWP <sup>1)</sup>	P.32
-	12	1.3	WX3x16d	7504DYP <sup>1)</sup>	P.30
-	12	2.0	W3x16d	7505DWP <sup>1)</sup>	P.30
-	12	1.4	W3x16d	7505DRP <sup>1)</sup>	P.30
-	12	1.3	W3x16d	7505DYP <sup>1)</sup>	P.30
-	12	1.9	BA15s	7506DWP <sup>1)</sup>	P.30
-	12	1.9	BA15s	7506DRP <sup>1)</sup>	P.30
-	12	1.3	BAU15s	7507DYP <sup>1)</sup>	P.30
-	12	1.9	W3x16q	7515DWP <sup>1)</sup>	P.30
-	12	1.7	W3x16q	7515DRP <sup>1)</sup>	P.30
-	12	1.7	W3x16q	7515DYP <sup>1)</sup>	P.30
-	12	2.0	BAY15d	7528DWP <sup>1)</sup>	P.30
-	12	1.4	BA15s	7528DRP <sup>1)</sup>	P.30
-	12	1.3	BA15s	7528DYP <sup>1)</sup>	P.30
-	12/24	14	P43t	9726CW	P.26
-	12/24	14	P22d	9736CW	P.26
-	12	13	PY20d	9745CW	P.28
-	12	80	P14.5s	62150CBB <sup>1)</sup>	P.66
-	12	100/90	P43t	62193CBB <sup>1)</sup>	P.66
-	12	100	P14.5s	62200SBP <sup>1)</sup>	P.64
-	12	100	PK22s	62201SBP <sup>1)</sup>	P.64
-	12	100/90	P43t	62204SBP <sup>1)</sup>	P.64
-	12	80	PX26d	62210CBB <sup>1)</sup>	P.66
-	12	75	PGJ19-2	62211CBB <sup>1)</sup>	P.66
-	12	80	PX26d	62261SBP <sup>1)</sup>	P.64
-	12	20	BA9s	64111	P.54
-	12	10	BA9s	64113	P.54
-	12	5	BA9s	64115	P.54
-	12	12	P14.5s	64150DWP	P.26
-	12	100	PX14.5s	64152SB <sup>1)</sup>	P.64
-	12	100	PKX22s	64153SB <sup>1)</sup>	P.64
-	12	5/5	PX43t	64185DWP <sup>1)</sup>	P.32
-	12	60/55	P45t	64198SB <sup>1)</sup>	P.64
-	12	-	-	64210DA01	P.25
-	12	-	-	64210DA01-1	P.25
-	12	-	-	64210DA02	P.25
-	12	-	-	64210DA03	P.37
-	12	-	-	64210DA03-1	P.25
-	12	-	-	64210DA04	P.25
-	12	-	-	64210DA05	P.25
-	12	-	-	64210DA06	P.37
-	12	-	-	64210DA07	P.25
-	12	-	-	64210DA08	P.25
-	12	23/27	P43t	64193DWNB	P.22
-	12	19	PX26d	64210DWNB	P.22
-	12/24	35	PK32d-2	66140CBB <sup>1)</sup>	P.66
-	12/24	35	P32d-2	66240CBB <sup>1)</sup>	P.66
-	12/24	35	PK32d-5	66340CBB <sup>1)</sup>	P.66
-	12/24	35	P32d-5	66440CBB <sup>1)</sup>	P.66
-	12/24	14	PX26d	67210CW	P.26
-	12/24	14	PGJ19-2	67211CW	P.26
-	12	13	PGJ19	67219CW	P.28
-	12	100	P20d	69005SBP <sup>1)</sup>	P.64
-	12	80	P22d	69006SBP <sup>1)</sup>	P.64
-	24	1	W2x4.6d	2341	P.58
-	24	1.2	W2x4.6d	2741	P.58
-	24	1.2	B8.5d	2741MF	P.58
-	24	1.2	BX8.5d	2741MFX	P.58

ECE	V	W		Product Reference	
-	24	2	W2.1x9.5d	2840	P.58
-	24	2	BA9s	3797	P.58
-	24	3	SV8.5-8	6421	P.58
-	24	3	SV8.5-8	6430	P.58
-	24	5	SV8.5-8	6424	P.58
-	24	10	SV8.5-8	6429	P.58
-	24	15	BA15s	7529	P.58
-	24	12	P14.5s	64155DWS <sup>1)</sup>	P.34
-	24	13/13	P43t	64196DWS <sup>1)</sup>	P.34
-	24	18	PX26d	64215DWS <sup>1)</sup>	P.34
C5W	12	5	SV8.5-8	6418	P.54
C5W	12	5	SV8.5-8	6418ULT	P.50
C5W	24	5	SV8.5-8	6423	P.58
D1S	85	35	PK32d-2	66140	P.42
D1S	85	35	PK32d-2	66140XNL	P.39
D1S	85	35	PK32d-2	66140CBN	P.40
D1S	85	35	PK32d-2	66140ULT	P.41
D1R	85	35	PK32d-3	66150	P.42
D1R	85	35	PK32d-3	66150CBN	P.40
D2S	85	35	P32d-2	66240	P.42
D2S	85	35	P32d-2	66240XNL	P.39
D2S	85	35	P32d-2	66240CBN	P.40
D2S	85	35	P32d-2	66240ULT	P.41
D2R	85	35	P32d-3	66250	P.42
D2R	85	35	P32d-3	66250CBN	P.40
D3S	42	35	PK32d-5	66340	P.42
D3S	42	35	PK32d-5	66340XNL	P.39
D3S	42	35	PK32d-5	66340CBN	P.40
D3S	42	35	PK32d-5	66340ULT	P.41
D3R	42	35	PK32d-6	66350	P.42
D4S	42	35	P32d-5	66440	P.42
D4S	42	35	P32d-5	66440XNL	P.39
D4S	42	35	P32d-5	66440CBN	P.40
D4S	42	35	P32d-5	66440ULT	P.41
D4R	42	35	P32d-6	66450	P.42
D5S	12	25	PK32d-7	66540	P.42
D8S	42	25	PK32d-1	66548	P.42
D8S	42	25	PK32d-1	66548CBN	P.40
H1	12	55	P14.5s	64150	P.52
H1	12	55	P14.5s	64150NL	P.46
H1	12	55	P14.5s	64150NBS	P.47
H1	12	55	P14.5s	64150CBN	P.48
H1	12	55	P14.5s	64150ULT	P.50
H1	24	70	P14.5s	64155	P.58
H1	24	70	P14.5s	64155TSP	P.56
H10	12	42	PY20d	9145	P.53
H11	12	55	PGJ19-2	64211	P.53
H11	12	55	PGJ19-2	64211NL	P.46
H11	12	55	PGJ19-2	64211NBS	P.47
H11	12	55	PGJ19-2	64211CBN	P.48
H11	12	55	PGJ19-2	64211ULT	P.50
H11	24	70	PGJ19-2	64216TSP	P.56
H11B	12	55	PGJY19-2	64241	P.53

ECE	V	W		Product Reference	
H13	12	60/55	P26.4t	9008	P.53
H15	12	55/15	PGJ23t-1	64176	P.53
H15	12	55/15	PGJ23t-1	64176CBN	P.48
H15	24	20/60	PGJ23t-1	64177	P.58
H16	12	19	PGJ19-3	64219L+	P.53
H18	12	55	PY26d-1	64180L	P.53
H19	12	60/55	PU43t-3	64181L	P.53
H21W	12	21	BAY9s	64136	P.54
H21W	24	21	BAY9s	64138	P.58
H27W/1	12	27	PG13	880	P.53
H27W/2	12	27	PGJ13	881	P.53
H3	12	55	PK22s	64151	P.52
H3	12	55	PK22s	64151NL	P.46
H3	24	70	PK22s	64156	P.58
H3	24	70	PK22s	64156TSP	P.56
H4	12	60/55	P43t	64193	P.52
H4	12	60/55	P43t	64193NB200	P.45
H4	12	60/55	P43t	64193NL	P.46
H4	12	60/55	P43t	64193NBS	P.47
H4	12	60/55	P43t	64193CBN	P.48
H4	12	60/55	P43t	64193ULT	P.50
H4	24	75/70	P43t	64196	P.58
H4	24	75/70	P43t	64196TSP	P.56
H4	24	75/70	P43t	94196	P.58
H6W	12	6	BAX9s	64132	P.54
H6W	12	6	BAX9s	64132ULT	P.50
H7	12	55	PX26d	64210	P.53
H7	12	55	PX26d	64210NB200	P.45
H7	12	55	PX26d	64210NL	P.46
H7	12	55	PX26d	64210NBS	P.47
H7	12	55	PX26d	64210CBN	P.48
H7	12	55	PX26d	64210ULT	P.50
H7	24	70	PX26d	64215	P.58
H7	24	70	PX26d	64215TSP	P.56
H8	12	35	PGJ19-1	64212	P.53
H8	12	35	PGJ19-1	64212NL	P.46
H8	12	35	PGJ19-1	64212CBN	P.48
H8B	12	35	PGJY19-1	64242	P.53
H9	12	65	PGJ19-5	64213	P.53
H9B	12	65	PGJY19-5	64243	P.53
HB3	12	60	P20d	9005	P.53
HB3	12	60	P20d	9005NL	P.46
HB3	12	60	P20d	9005CBN	P.48
HB3A	12	60	P20d	9005XS	P.53
HB4	12	51	P22d	9006	P.53
HB4	12	51	P22d	9006NL	P.46
HB4	12	51	P22d	9006CBN	P.48
HB4A	12	51	P20d	9006XS	P.53
HB5	12	65/55	PX29t	9007	P.53
HIR1	12	65	PX20d	9011	P.53
HIR2	12	55	PX22d	9012	P.53
HIR2	12	55	PX22d	9012CBN	P.48
HS1	12	35/35	PX43t	64185	P.62

ECE	V	W		Product Reference		
HY21W	12	21	BAW9s	64137ULT	P.50	
P13W	12	13	PG18,5d-1	828	P.54	
P21W	12	21	BA15s	7506	P.53	
P21W	12	21	BA15s	7506ULT	P.50	
P21W	24	21	BA15s	7511	P.58	
P21W	24	21	BA15s	7511TSP	P.56	
P21/4W	12	21/4	BAZ15d	7225	P.53	
P21/5W	12	21/5	BAY15d	7528	P.53	
P21/5W	12	21/5	BAY15d	7528ULT	P.50	
P21/5W	24	21/5	BAY15d	7537	P.58	
P21/5W	24	21/5	BAY15d	7537TSP	P.56	
P27W	12	27	W2.5x16d	3156	P.53	
P27/7W	12	27/7	W2.5x16q	3157	P.53	
PS19W	12	19	PG20-1	5201	P.54	
PS24W	12	24	PG20-3	5202	P.54	
PSX24W	12	24	PG20-7	2504	P.54	
PSX26W	12	26	PG18.5d-3	6851	P.54	
PY21W	12	21	BAU15s	7507	P.53	
PY21W	12	21	BAU15s	7507ULT	P.50	
PY21W	12	21	BAU15s	7507DC	P.49	
PY21W	24	21	BAU15s	7510TSP	P.56	
PY27/7W	12	27/7	WX2.5x16q	3757AK	P.54	
R10W	12	10	BA15s	5008	P.54	
R10W	12	10	BA15s	5008ULT	P.50	
R10W	24	10	BA15s	5637	P.58	
R10W	24	10	BA15s	5637TSP	P.56	

ECE	V	W		Product Reference		
R5W	12	5	BA15s	5007	P.54	
R5W	12	5	BA15s	5007ULT	P.50	
R5W	24	5	BA15d	5626	P.58	
R5W	24	5	BA15s	5627	P.58	
R5W	24	5	BA15s	5627TSP	P.56	
RY10W	12	10	BAU15s	5009	P.54	
S1	12	25/25	BA20d	64326	P.62	
S2	12	35/35	BA20d	64327	P.62	
T4W	12	4	BA9s	3893	P.53	
T4W	24	4	BA9s	3930	P.58	
T4W	24	4	BA9s	3930TSP	P.56	
W16W	12	16	W2.1x9.5d	921	P.53	
W2.3W	12	2.3	W2x4.6d	2723	P.54	
W21/5W	12	21/5	W3x16q	7515	P.54	
W21W	12	21	W3x16d	7505	P.53	
W3W	12	3	W2.1x9.5d	2821	P.54	
W3W	24	3	W2.1x9.5d	2841	P.58	
W5W	12	5	W2.1x9.5d	2825	P.53	
W5W	12	5	W2.1x9.5d	2825ULT	P.50	
W5W	12	5	W2.1x9.5d	2825CBN	P.48	
W5W	24	5	W2.1x9.5d	2845	P.58	
W5W	24	5	W2.1x9.5d	2845TSP	P.56	
WY5W	12	5	W2.1x9.5d	2827NA	P.53	
WY16W	12	16	W2.1x9.5d	921NA	P.53	
WY5W	12	5	W2.1x9.5d	2827DC	P.49	
WY21W	12	21	WX3x16d	7504	P.53	

1) These products do not have ECE approval and must not be used on public roads in any exterior application. Public roads use leads to cancellation of operating license and loss of insurance coverage. Several countries forbid sale and use of these products. Please contact your local distributor for further information.

# Type overview in numerical order of product reference with test data

Product Reference	ECE	V	W		V <sub>Test</sub>	W <sub>In</sub>	lm	T <sub>h</sub> <sup>1)</sup> E5/7c	
828	P13W	12	13	PG18,5d-1	13.5	19	250	1000	P.54
828DWP <sup>2)</sup>	-	12	1.6	PG18.5d-1	13.5	1.9	130	1500/4000	P.30
880	H27W/1	12	27	PG13	13.5	31	450	-	P.53
881	H27W/2	12	27	PGJ13	13.5	31	450	-	P.53
921	W16W	12	16	W2.1x9.5d	13.5	19.4	310	400/1000	P.53
921DWP <sup>2)</sup>	-	12	2.1	W2.1x9.5d	13.5	2.9	280	1500/4000	P.30
921DRP <sup>2)</sup>	-	12	1.4	W2.1x9.5d	13.5	2.00	80	1500/4000	P.30
921NA	WY16W	12	16	W2.1x9.5d	13.5	19.4	190	400/1000	P.53
2341	-	24	1	W2x4.6d	28.0	1	3	300/1000	P.58
2351MFX6	-	12	1.2	BX8.4d	13.5	1.32	7.5	600/3000	P.54
2352MFX6	-	12	2	BX8.4d	13.5	2.13	11.8	1500/6000	P.54
2452MFX6	-	12	1.5	BX8.4d	13.5	1.8	6.5	1700/6500	P.54
2473MFX6	-	12	1.12	BX8.4d	14.0	1.12	3.6	500/5000	P.54
2504	PSX24W	12	24	PG20-7	13.5	max. 25	500	500/1000	P.54
2604CW	-	12	6.7	PG20-7	13.2	6.7	730	2500/5000	P.28
2721	-	12	1.2	W2x4.6d	13.5	1.22	7.5	500/2000	P.54
2721MF	-	12	1.2	B8.5d	13.5	1.2	6.4	500/2000	P.54
2721MFX	-	12	1.2	BX8.5d	13.5	1.2	6.4	500/2000	P.54
2722	-	12	2	W2x4.6d	13.5	2	12	1300/4000	P.54
2722MF	-	12	2	B8.5d	13.5	2	10.2	1300/4000	P.54
2722MFX	-	12	2	BX8.5d	13.5	2	10.2	1300/4000	P.54
2723	W2.3W	12	2.3	W2x4.6d	13.5	2.5	18.6	350/1200	P.54
2723DWP <sup>2)</sup>	-	12	0.25	W2x4.6d	-	-	-	-	P.30
2741	-	24	1.2	W2x4.6d	28.0	1.6	7.5	400/2000	P.58
2741MF	-	24	1.2	B8.5d	28.0	1.6	6.4	400/2000	P.58
2741MFX	-	24	1.2	BX8.5d	28.0	1.6	6.4	400/2000	P.58
2820	-	12	2	W2.1x9.5d	13.5	2.2	13.5	600/4000	P.53
2821	W3W	12	3	W2.1x9.5d	13.5	3	22	1300/4000	P.54
2825	W5W	12	5	W2.1x9.5d	13.5	5	50	350/1000	P.53
2825DWP <sup>2)</sup>	-	12	0.8	W2.1x9.5d	13.5	1.12	70	1500/4000	P.30
2825DRP <sup>2)</sup>	-	12	0.6	W2.1x9.5d	13.5	0.8	15	1500/4000	P.30
2825CBN	W5W	12	5	W2.1x9.5d	13.5	5	50	350/1000	P.48
2825ULT	W5W	12	5	W2.1x9.5d	13.5	5	50	700/1500	P.50
2827DC	WY5W	12	5	W2.1x9.5d	13.5	5	30	200/500	P.49
2827DYP <sup>2)</sup>	-	12	1	W2.1x9.5d	13.5	0.7	7	1500/4000	P.30
2827NA	WY5W	12	5	W2.1x9.5d	13.5	5	30	350/1000	P.53
2840	-	24	2	W2.1x9.5d	28.0	2.6	13	500/5000	P.58
2841	W3W	24	3	W2.1x9.5d	28.0	4	22	500/5000	P.58
2845	W5W	24	5	W2.1x9.5d	28.0	7	50	800/3000	P.58
2845TSP	W5W	24	5	W2.1x9.5d	28.0	7	50	1000/4000	P.56
2886X	-	12	6	W2.1x9.5d	13.5	6	85	400/1000	P.53
3156	P27W	12	27	W2.5x16d	13.5	29.2	475	600/0	P.53
3157	P27/7W	12	27/7	W2.5x16q	13.5	29.2/7.7	475/36	600/5000	P.53
3157DWP <sup>2)</sup>	-	12	2.0	W3x16q	13.5	2.5/0.6	145/30	1500/4000	P.30
3157DRP <sup>2)</sup>	-	12	1.4	W3x16q	13.5	1.8/0.6	60/10	1500/4000	P.30
3157DYP <sup>2)</sup>	-	12	1.3	W3x16q	13.5	1.7/1.1	55/10	1500/4000	P.30
3757AK	PY27/7W	12	27/7	WX2.5x16q	13.5	29.2/17.7	280/21	460/1100	P.53
3796	-	12	2	BA9s	13.5	2	12.5	300/750	P.54
3797	-	24	2	BA9s	28	3	17.5	1000/2000	P.58
3860	-	12	5	BA9s	13.5	5	50	400/1000	P.53



Product Reference	ECE	V	W		V <sub>Test</sub>	W <sub>In</sub>	lm	T[h] E5/7c 1)	
3893	T4W	12	4	BA9s	13.5	4	35	600/1200	P.53
3893DWP <sup>2)</sup>	-	12	0.8	BA9s	13.5	1.0	75	1500/4000	P.30
3930	T4W	24	4	BA9s	28.0	5	35	250/500	P.58
3930TSP	T4W	24	4	BA9s	28.0	5	35	550/1000	P.56
5007	R5W	12	5	BA15s	13.5	5	50	350/800	P.54
5007DWP <sup>2)</sup>	-	12	0.5	BA15s	-	-	-	-	P.30
5007ULT	R5W	12	5	BA15s	13.5	5	50	600/1200	P.50
5008	R10W	12	10	BA15s	13.5	10	125	350/800	P.54
5008DWP <sup>2)</sup>	-	12	1.2	BA15s	-	-	-	-	P.30
5008ULT	R10W	12	10	BA15s	13.5	10	125	600/1200	P.50
5009	RY10W	12	10	BAU15s	13.5	10	75	350/800	P.54
5201	PS19W	12	19	PG20-1	13.5	max. 20	350	500/1000	P.54
5201DWP <sup>2)</sup>	-	12	1.6	PG20-1	13.5	1.9	140	1500/4000	P.30
5202	PS24W	12	24	PG20-3	13.5	max. 25	500	500/1000	P.54
5626	R5W	24	5	BA15d	28.0	7	50	80/250	P.58
5627	R5W	24	5	BA15s	28.0	7	50	500/1000	P.58
5627TSP	R5W	24	5	BA15s	28.0	7	50	800/2000	P.58
5637	R10W	24	10	BA15s	28.0	12.5	125	400/800	P.58
5637TSP	R10W	24	10	BA15s	28.0	12.5	125	1000/2000	P.56
6411	-	12	10	SV8.5-8	13.5	10	100	500/1000	P.54
6413	-	12	5	SV8.5-8	13.5	5	45	1000/2000	P.54
6413DWP <sup>2)</sup>	-	12	0.6	SV8.5-8	13.5	0.8	55	2500/5000	P.30
6418	C5W	12	5	SV8.5-8	13.5	5	45	1000/2000	P.54
6418DWP <sup>2)</sup>	-	12	0.6	SV8.5-8	13.5	0.8	45	2500/5000	P.30
6418ULT	C5W	12	5	SV8.5-8	13.5	5	45	1500/4000	P.50
6421	-	24	3	SV8.5-8	24.0	3	17	800/1500	P.58
6423	C5W	24	5	SV8.5-8	28.0	7	45	1500/4000	P.58
6424	-	24	5	SV8.5-8	28.0	7	60	1000/2000	P.58
6428	-	12	3	SV7-8	13.5	3.5	29	600/1200	P.54
6429	-	24	10	SV8.5-8	28.0	10	105	300/600	P.58
6430	-	24	3	SV7-8	28.0	3	23	400/800	P.58
6438	-	12	10	SV8.5-8	13.0	10	120	200/500	P.54
6438DWP <sup>2)</sup>	-	12	1	SV8.5-8	13.5	45	1.2	2500/5000	P.30
6461	-	12	10	SV8.5-8	13.5	10	105	600/1200	P.54
6486X	-	12	6	SV8.5-8	13.5	6	85	350/600	P.54
6851	PSX26W	12	26	PG18.5d-3	13.5	26	500	1000	P.54
7225	P21/4W	12	21/4	BAZ15d	13.5	25/5	440/15	180/1250 //290/4000	P.53
7240	-	12	21/5	BA15d	13.5	25/6	440/35	180/1250//290/4000	P.53
7335DWP <sup>2)</sup>	-	12	5/5	P15d-25-1	-	-	-	-	P.32
7504	WY21W	12	21	WX3x16d	13.5	25	280	400/600	P.53
7504DYP <sup>2)</sup>	-	12	1.3	WX3x16d	13.5	1.8	55	1500/4000	P.30
7505	W21W	12	21	W3x16d	13.5	25	460	400/600	P.53
7505DWP <sup>2)</sup>	-	12	2	W3x16d	13.5	2.8	145	1500/4000	P.30
7505DRP <sup>2)</sup>	-	12	1.4	W3x16d	13.5	2.0	60	1500/4000	P.30
7505DYP <sup>2)</sup>	-	12	1.3	W3x16d	13.5	2.0	55	1500/4000	P.30
7506	P21W	12	21	BA15s	13.5	25	460	250/500	P.53
7506DWP <sup>2)</sup>	-	12	1.9	BA15s	13.5	2.5	160	1500/4000	P.30
7506DYP <sup>2)</sup>	-	12	1.3	BA15s	13.5	2.8	100	1500/4000	P.30
7506DRP <sup>2)</sup>	-	12	1.3	BA15s	13.5	2.8	50	1500/4000	P.30
7506ULT	P21W	12	21	BA15s	13.5	25	460	500/1000	P.50

Product Reference	ECE	V	W		V <sub>Test</sub>	W <sub>in</sub>	lm	T[h] E5/7c 1)	
7507	PY21W	12	21	BAU15s	13.5	25	280	250/500	P.53
7507DC	PY21W	12	21	BAU15s	13.5	25	280	100/250	P.49
7507DYP <sup>2)</sup>	-	12	1.3	BAU15s	13.5	1.8	50	1500/4000	P.30
7507ULT	PY21W	12	21	BAU15s	13.5	25	280	500/1000	P.50
7510TSP	PY21W	24	21	BAU15s	28.0	28	250	250/500	P.56
7511	P21W	24	21	BA15s	28.0	28	460	200/400	P.58
7511TSP	P21W	24	21	BA15s	28.0	28	460	250/500	P.56
7515	W21/5W	12	21/5	W3x16q	13.5	25/6	440/35	400/600//3000/3000	P.54
7515DWP <sup>2)</sup>	-	12	1.9	W3x16q	13.5	2.7/0.6	155/25	1500/4000	P.30
7515DRP <sup>2)</sup>	-	12	1.7	W3x16q	13.5	2.4/0.6	80/10	1500/4000	P.30
7515DYP <sup>2)</sup>	-	12	1.7	W3x16q	13.5	1.8/1.3	50/10	1500/4000	P.30
7528	P21/5W	12	21/5	BAY15d	13.5	25/6	440/35	180/1250//290/4000	P.53
7528DWP <sup>2)</sup>	-	12	2	BAY15d	13.5	2.5/0.5	145/30	1500/4000	P.30
7528DRP <sup>2)</sup>	-	12	1.4	BAY15d	13.5	1.6/0.6	100/10	1500/4000	P.30
7528DYP <sup>2)</sup>	-	12	1.3	BAY15d	13.5	1.5/0.9	55/10	1500/4000	P.30
7528ULT	P21/5W	12	21/5	BAY15d	13.5	25/6	440/35	300/3000//800/6000	P.50
7529	-	24	15	BA15s	28.0	15	210	100/300	P.58
7537	P21/5W	24	21/5	BAY15d	28.0	28/10	440/40	60/600//160/1600	P.58
7537TSP	P21/5W	24	21/5	BAY15d	28.0	28/10	440/40	100/1000//200/2000	P.56
9005	HB3	12	60	P20d	13.2	73	1860	280/550	P.53
9005NL	HB3	12	60	P20d	13.2	73	1860	110/210	P.46
9005CBN	HB3	12	60	P20d	13.2	73	1860	110/220	P.48
9005XS	HB3A	12	60	P20d	13.2	max. 73	1860	-	P.53
9006	HB4	12	51	P22d	13.2	62	1095	860/1720	P.53
9006NL	HB4	12	51	P22d	13.2	62	1095	270/500	P.46
9006CBN	HB4	12	51	P22d	13.2	62	1095	260/520	P.48
9006XS	HB4A	12	51	P20d	13.2	62	1095	860/1720	P.53
9007	HB5	12	65/55	PX29t	12.8	70/60	1350/1000	250/500	P.53
9008	H13	12	60/55	P26.4t	13.2	75/68	1700/1100	170/1290//350/2590	P.53
9011	HIR1	12	65	PX20d	13.2	max. 73	2500	220/300	P.53
9012	HIR2	12	55	PX22d	13.2	max. 63	1875	500/870	P.53
9012CBN	HIR2	12	55	PX22d	13.2	63	1875	300/500	P.48
9145	H10	12	42	PY20d	13.2	50	850	860/1720	P.53
9745CW <sup>2)</sup>	-	12	13	PY20d	-	-	730	-	P.28
9726CW <sup>2)</sup>	-	12	-	P43t	-	-	-	-	P.26
9736CW <sup>2)</sup>	-	12	-	P22t	-	-	-	-	P.26
62150CBB <sup>2)</sup>	-	12	80	P14.5s	13.2	80	1150	75/150	P.66
62193CBB <sup>2)</sup>	-	12	100/90	P43t	13.2	100/90	1600/760	60/200//120/400	P.66
62200SBP <sup>2)</sup>	-	12	100	P14.5s	13.2	max. 94	2600	23/50	P.64
62201SBP <sup>2)</sup>	-	12	100	PK22s	13.2	max. 95	2300	22/50	P.64
62204SBP <sup>2)</sup>	-	12	100/90	P43t	13.2	100/90	2900/1530	100/200//300/550	P.64
62210CBB <sup>2)</sup>	-	12	80	PX26d	13.2	80	1100	150/350	P.66
62211CBB <sup>2)</sup>	-	12	75	PGJ19-2	13.2	75	1000	200/400	P.66
62261SBP <sup>2)</sup>	-	12	80	PX26d	13.2	80	1950	250/500	P.64
64111	-	12	5	BA9s	13.5	5	80	150/500	P.54
64113	-	12	10	BA9s	13.5	10	200	150/400	P.54
64115	-	12	20	BA9s	13.5	22.5	450	150/500	P.54
64132	H6W	12	6	BAX9s	13.5	7	125	350/700	P.53
64132ULT	H6W	12	6	BAX9s	13.5	7	125	600/1000	P.50
64136	H21W	12	21	BAY9s	13.5	25	600	300/600	P.54

Product Reference	ECE	V	W		V <sub>Test</sub>	W <sub>th</sub>	lm	T <sub>h</sub> <sup>1)</sup> E5/TC	
64137ULT	HY21W	12	21	BAW9s	13.5	26.25	300	400/700	P.50
64138	H21W	24	21	BAY9s	28.0	28	600	150/400	P.58
64150	H1	12	55	P14.5s	13.2	68	1550	400/650	P.52
64150DWP	(H1)	12	12	P14.5s	-	-	-	-	P.26
64150NL	H1	12	55	P14.5s	13.2	68	1550	150/300	P.46
64150NBS	H1	12	55	P14.5s	13.2	68	1550	250/450	P.47
64150CBN	H1	12	55	P14.5s	13.2	68	1550	150/250	P.48
64150ULT	H1	12	55	P14.5s	13.2	68	1550	1200/2000	P.50
64151	H3	12	55	PK22s	13.2	68	1450	400/650	P.52
64151NL	H3	12	55	PK22s	13.2	68	1450	150/300	P.46
64152SB <sup>2)</sup>	-	12	100	PX14,5s	13.2	93	2600	22.5/50	P.64
64153SB <sup>2)</sup>	-	12	100	PKX22s	13.2	85	2300	23/50	P.64
64155	H1	24	70	P14.5s	28.0	84	1900	400/650	P.58
64155DWS <sup>2)</sup>	(H1)	24	12	P14.5s	-	-	-	-	P.34
64155TSP	H1	24	70	P14.5s	28.0	84	1900	600/1200	P.56
64156	H3	24	70	PK22s	28.0	84	1750	400/650	P.58
64156TSP	H3	24	70	PK22s	28.0	max. 84	1750	600/1200	P.56
64176	H15	12	55/15	PGJ23t-1	13.2	19/64	260/1350	2000/250//4000/500	P.53
64176CBN	H15	12	55/15	PGJ23t-1	13.2	max. 19/64	260/1350	1000/100//2000/200	P.48
64177	H15	24	20/60	PGJ23t-1	28.0	max. 84	300/1500	1500/200//3000/400	P.58
64180L	H18	12	55	PY26d-1	13.2	max. 69	1700	700/1100	P.53
64181L	H19	12	60/55	PU43t-3	13.2	max. 68/72	1750/1200	300/600//800/1600	P.53
64185	HS1	12	35/35	PX43t	13.2	36.8/36.8	820/520	75/150//150/300	P.62
64185DWP <sup>2)</sup>	(HS1)	12	5/5	PX43t	-	-	-	-	P.32
64193	H4	12	60/55	P43t	13.2	75/68	1650/1000	250/400//500/900	P.53
64193DWNB <sup>2)</sup>	(H4)	12	23/27	P43t	-	-	-	-	P.22
64193NB200	H4	12	60/55	P43t	13.2	75/68	1650/1000	-	P.45
64193NL	H4	12	60/55	P43t	13.2	75/68	1650/1000	80/200//160/400	P.46
64193NBS	H4	12	60/55	P43t	13.2	75/68	1650/1000	250/400//450/700	P.47
64193CBN	H4	12	60/55	P43t	13.2	75/68	1650/1000	50/200//100/400	P.48
64193ULT	H4	12	60/55	P43t	13.2	75/68	1650/1000	300/2000//700/3000	P.50
64196	H4	24	75/70	P43t	28.0	85/80	1900/1200	170/350//400/800	P.58
64196DWS <sup>2)</sup>	(H4)	24	13/13	P43t	-	-	-	-	P.34
64196TSP	H4	24	75/70	P43t	28.0	85/80	1900/1200	140/450//300/1000	P.56
64198SB <sup>2)</sup>	-	12	60/55	P45t	13.2	75/68	1650/1000	250/400//500/900	P.64
64210DA01	-	12	-	-	-	-	-	-	P.25
64210DA01-1	-	12	-	-	-	-	-	-	P.25
64210DA02	-	12	-	-	-	-	-	-	P.25
64210DA03	-	12	-	-	-	-	-	-	P.37
64210DA03-1	-	12	-	-	-	-	-	-	P.25
64210DA04	-	12	-	-	-	-	-	-	P.25
64210DA05	-	12	-	-	-	-	-	-	P.25
64210DA06	-	12	-	-	-	-	-	-	P.37
64210DA07	-	12	-	-	-	-	-	-	P.25
64210DA08	-	12	-	-	-	-	-	-	P.25
64210	H7	12	55	PX26d	13.2	58	1500	330/550	P.53
64210DWNB	(H7)	12	19	PX26d	-	-	-	-	P.22
64210NB200	H7	12	55	PX26d	13.2	58	1500	-	P.45
64210NL	H7	12	55	PX26d	13.2	58	1500	150/250	P.46
64210NBS	H7	12	55	PX26d	13.2	58	1500	250/450	P.47

Product Reference	ECE	V	W		V <sub>Test</sub>	W <sub>h</sub>	lm	T <sub>h</sub> E5/7c 1)	
64210CBN	H7	12	55	PX26d	13.2	58	1500	100/200	P.48
64210ULT	H7	12	55	PX26d	13.2	58	1500	1000/1500	P.50
64212	H8	12	35	PGJ19-1	13.2	43	800	400/800	P.53
64212NL	H8	12	35	PGJ19-1	13.2	max. 43	800	250/500	P.46
64212CBN	H8	12	35	PGJ19-1	13.2	43	800	250/500	P.48
64213	H9	12	65	PGJ19-5	13.2	73	2100	250/500	P.53
64215	H7	24	70	PX26d	28.0	75	1750	220/500	P.58
64215DWS <sup>2)</sup>	(H7)	12	13/13	PX26d	-	-	-	-	P.34
64215TSP	H7	24	70	PX26d	28.0	75	1750	500/1000	P.56
64216TSP	H11	24	70	PGJ19-2	28.0	max. 80	1600	500/1000	P.56
64219L+	H16	12	19	PGJ19-3	13.2	26	500	1115/2000	P.53
64241	H11B	12	55	PGJY19-2	13.2	62	1350	350/580	P.53
64242	H8B	12	35	PGJY19-1	13.2	43	800	400/800	P.53
64243	H9B	12	65	PGJY19-5	13.2	73	2100	250/500	P.53
64326	S1	12	25/25	BA20d	13.5	25/25	430/310	-	P.62
64327	S2	12	35/35	BA20d	13.5	35/35	650/460	80/160	P.62
66140	D1S	85	35	PK32d-2	13.5	35	3200	2000/3000	P.42
66140XNL	D1S	85	35	PK32d-2	13.5	35	3200	1500/3000	P.39
66140CBN	D1S	85	35	PK32d-2	13.5	35	3200	1500/3000	P.40
66140ULT	D1S	85	35	PK32d-2	13.5	35	3200	-	P.41
66140CBB <sup>2)</sup>	-	85	35	PK32d-2	13.2	35	3200	600/1500	P.66
66150	D1R	85	35	PK32d-3	13.5	35	2800	2000/3000	P.42
66150CBN	D1R	85	35	PK32d-3	13.5	35	2800	1500/3000	P.40
66240	D2S	85	35	P32d-2	13.5	35	3200	2000/3000	P.42
66240XNL	D2S	85	35	P32d-2	13.5	35	3200	1500/3000	P.39
66240CBN	D2S	85	35	P32d-2	13.5	35	3200	1800/2800	P.40
66240ULT	D2S	85	35	P32d-2	13.5	35	3200	-	P.41
66240CBB <sup>2)</sup>	-	85	35	P32d-2	13.2	35	3200	600/1500	P.66
66250	D2R	85	35	P32d-3	13.5	35	2800	2000/3000	P.42
66250CBN	D2R	85	35	P32d-3	13.5	35	2800	1500/2000	P.40
66340	D3S	42	35	PK32d-5	13.5	35	3200	2000/4000	P.42
66340XNL	D3S	42	35	PK32d-5	13.5	35	3200	2000/3000	P.39
66340CBN	D3S	42	35	PK32d-5	13.5	35	3200	2000/3000	P.40
66340ULT	D3S	42	35	PK32d-5	13.5	35	3200	-	P.41
66340CBB <sup>2)</sup>	-	85	35	PK32d-5	13.2	35	3200	-	P.66
66350	D3R	42	35	PK32d-6	13.5	35	2800	2000/3000	P.42
66440	D4S	42	35	P32d-5	13.5	35	3200	2000/4000	P.42
66440XNL	D4S	42	35	P32d-5	13.5	35	3200	2000/3000	P.39
66440CBN	D4S	42	35	P32d-5	13.5	35	3200	2000/3000	P.40
66440ULT	D4S	42	35	P32d-5	13.5	35	3200	-	P.41
66440CBB <sup>2)</sup>	-	85	35	P32d-5	13.2	35	3200	-	P.66
66450	D4R	42	35	P32d-6	13.5	35	2800	2000/3000	P.42
66540	D5S	12	25	PK32d-7	13.2	25	2000	2500/4000	P.42
66548	D8S	42	25	PK32d-1	13.5	25	2000	2500/4000	P.42
66548CBN	D8S	42	25	PK32d-1	13.5	25	2000	-	P.40
67210CW	-	12	-	PX26d	-	-	-	-	P.26
67211CW	-	12	-	PGJ19-2	-	-	-	-	P.26
67219CW	-	12	13	PGJ19	12	13	730	-	P.28
69005SBP <sup>2)</sup>	-	12	100	P20d	13.2	100	2885	280/550	P.64
69006SBP <sup>2)</sup>	-	12	80	P22d	13.2	max. 80	1890	600/1200	P.64

Product Reference	ECE	V	W		V <sub>Test</sub>	W <sub>In</sub>	lm	T <sub>h</sub> E5/7c	1)
94196	H4	24	75/70	P43t	28.0	85/80	1900/1200	170/500//400/1500	P.58
LEDCAP01	-	12	-	-	-	-	-	-	P.24
LEDCAP02	-	12	-	-	-	-	-	-	P.24
LEDCAP03	-	12	-	-	-	-	-	-	P.24
LEDCAP04	-	12	-	-	-	-	-	-	P.24
LEDCBCTRL101	-	12	5	-	-	-	-	-	P.36
LEDCBCTRL102	-	12	21	-	-	-	-	-	P.36
LEDCBCTRL103	-	12	50	-	-	-	-	-	P.36
LEDDL ACC 101	-	12	-	-	-	-	-	-	P.84
LEDDL ACC 102	-	12	-	-	-	-	-	-	P.84
LEDDL ACC 103	-	12	-	-	-	-	-	-	P.84
LEDDL101-SP	-	12/24	22/2	-	13.5	22/2	1250	5000	P.86
LEDDL101-WD	-	12/24	22/2	-	13.5	22/2	1250	5000	P.86
LEDDL102-SP	-	12/24	30/2	-	13.5	30/2	2000	5000	P.84
LEDDL102-WD	-	12/24	30/2	-	13.5	30/2	2000	5000	P.86
LEDDL103-SP	-	12/24	35	-	13.2	35	2700	5000	P.82
LEDDL103-CB	-	12/24	35	-	13.2	35	2700	5000	P.82
LEDDL104-SP	-	12/24	36	-	13.2	36	4600	5000	P.82
LEDDL104-CB	-	12/24	68	-	13.2	36	4600	5000	P.82
LEDDL104-CB SM	-	12/24	68	-	13.2	36	4600	5000	P.82
LEDDL105-SP	-	12/24	14	-	13.2	14	1300	5000	P.82
LEDDL106-SP	-	12/24	29	-	13.2	29	2600	5000	P.82
LEDDL106-CB	-	12/24	29	-	13.2	29	2600	5000	P.82
LEDDL107-SP	-	12/24	46	-	13.2	46	3900	5000	P.82
LEDDL107-CB	-	12/24	44	-	13.2	46	3900	5000	P.82
LEDDL108-WD	-	12/24	15	-	13.2	15	1100	5000	P.85
LEDDL109-WD	-	12/24	15	-	13.2	15	1100	5000	P.85
LEDDL110-CB	-	12/24	45/1	-	13.2	49/1	2700	5000	P.84
LEDDL111-CB	-	12/24	39/1	-	13.2	39/1	3000	5000	P.84
LEDDL112-CB	-	12/24	60/2.5	-	13.2	60/2.5	3500	5000	P.84
LEDDL113-CB	-	12/24	70/1.5	-	13.2	70/1.5	4000	5000	P.84
LEDDL115-SP	-	12/24	27	-	13.2	27	1500	5000	P.85
LEDDL116-SP	-	12/24	63	-	13.2	63	2800	5000	P.85
LEDDL117-CB	-	12/24	30	-	13.2	30	2100	5000	P.85
LEDDL118-CB	-	12/24	55	-	13.2	55	4100	5000	P.85
LEDDL119-WD	-	12/24	22	-	13.2	22	1150	5000	P.85
LEDDL120-CB SM	-	12/24	108	-	13.2	108	-	-	P.85
LEDDMI 5G0 WT S	-	12	2.4	-	13.2	2.4	-	5000	P.76
LEDDMI 5G0 BK S	-	12	2.4	-	13.2	2.4	-	5000	P.76
LEDDMI 5K0 WT S	-	12	2.4	-	13.2	2.4	-	5000	P.76
LEDDMI 5K0 BK S	-	12	2.4	-	13.2	2.4	-	5000	P.76
LEDDMI 3G0 WT S	-	12	2.4	-	13.2	2.4	-	5000	P.76
LEDDMI F20 WT S	-	12	4.56	-	13.2	4.56	-	5000	P.78
LEDDMI F20 BK S	-	12	4.56	-	13.2	4.56	-	5000	P.78
LEDDMI 5F0 WT S	-	12	2.4	-	13.2	2.4	-	5000	P.78
LEDDMI 5F0 BK S	-	12	2.4	-	13.2	2.4	-	5000	P.78
LEDDMI 8W0 WT S	-	12	2.4	-	13.2	2.4	-	5000	P.79
LEDDMI 8W0 BK S	-	12	2.4	-	13.2	2.4	-	5000	P.79
LEDDMI 8V0 WT S	-	12	2.4	-	13.2	2.4	-	5000	P.79
LEDDMI 8V0 BK S	-	12	2.4	-	13.2	2.4	-	5000	P.79



Product Reference	ECE	V	W		V <sub>Test</sub>	W <sub>in</sub>	Im	T <sub>h</sub> E5/7c	1)
LEDDL102	-	12	15	-	14.0	15	300	5000	P.88
LEDDL301CL15	-	12	13.5	-	14.0	13.5	300	5000	P.88
LEDHL102-BK	-	12	70	-	-	-	-	-	P.74
LEDHL102-BK RHD	-	12	70	-	-	-	-	-	P.74
LEDHL102-CM	-	12	70	-	-	-	-	-	P.74
LEDHL102-GTI	-	12	70	-	-	-	-	-	P.74
LEDHL103-GTI	-	12	70	-	-	-	-	-	P.70
LEDHL103-BK	-	12	70	-	-	-	-	-	P.70
LEDHL103-CM	-	12	70	-	-	-	-	-	P.70
LEDHL103-CM RHD	-	12	70	-	-	-	-	-	P.70
LEDHL104-GTI	-	12	-	-	-	-	-	-	P.70
LEDHL104-BK	-	12	-	-	-	-	-	-	P.70
LEDHL104-CM	-	12	-	-	-	-	-	-	P.70
LEDHL105	-	12	70	-	-	-	-	-	P.74
LEDHL107-BK	-	12	-	-	-	-	-	-	P.72
LEDHL107-BK RHD	-	12	-	-	-	-	-	-	P.72
LEDHL108-BK	-	12	-	-	-	-	-	-	P.73
LEDHL108-CM	-	12	-	-	-	-	-	-	P.73
LEDHL109-BK	-	12	-	-	-	-	-	-	P.72
LEDHL109-GTI	-	12	-	-	-	-	-	-	P.72
LEDIL104	-	220	13-15	-	90-250	13-15	1.400	-	P.96
LEDIL202	-	4.5	1.6	-	-	-	125/90	5000	P.96
LEDIL203	-	4.5	1.5	-	-	-	80	5000	P.97
LEDIL209	-	4.5	3	-	-	-	300/60	6500	P.97
LEDIL401	-	3.7	7.4	-	-	-	-	-	P.97
LEDIL402	-	3.7	16.5	-	-	-	-	-	P.98
LEDIL403	-	3.7	9.62	-	-	-	-	-	P.98
LEDIL404	-	3.7	5.55	-	-	-	-	-	P.98
LEDIL405	-	3.7	9.25	-	-	-	-	-	P.99
LEDIL406	-	3.7	9.25	-	-	-	-	-	P.99
LEDIL407	-	3.7	19.24	-	-	-	-	-	P.99
LEDIL408	-	3.7	2.96	-	-	-	-	-	P.100
LEDIL409	-	3.7	9.62	-	-	-	-	-	P.100
LEDIL410	-	3.7	10	-	-	-	-	-	P.100
LEDIL411	-	3.7	2.96	-	-	-	-	-	P.101
LEDIL412	-	3.7	8.14	-	-	-	-	-	P.101
LEDIL HELI 1000	-	3.7	10	-	-	-	-	1000/500	P.94
LEDIL SPACE 1000	-	3.7	20	-	-	-	-	1000/500	P.94
LEDIL FLOOD 10W	-	3.7	10	-	-	-	-	1000	P.95
LEDIL FLOOD 20W	-	3.7	20	-	-	-	-	2000	P.95
LEDIL PRO 180	-	4.5	12	-	-	-	-	180/40	P.95
LEDIL MN CP 80	-	4.5	-	-	-	-	-	80/40	P.96
LEDINT201	-	12	-	-	-	-	-	-	P.90
LEDINT201-SEC	-	12	-	-	-	-	-	-	P.90
LEDINT202	-	12	-	-	-	-	-	-	P.90
LEDINT203	-	12	-	-	-	-	-	-	P.90
LEDSC01-2HFB	-	12	-	-	-	-	-	-	P.37
LEDSC01-2HFB	-	12	-	-	-	-	-	-	P.24
LEDSC02-1-2HFB	-	12	-	-	-	-	-	-	P.24
LEDSC03-2HFB	-	12	-	-	-	-	-	-	P.24

Product Reference	ECE	V	W		V <sub>Test</sub>	W <sub>in</sub>	Im	T[h] B3/Tc 1)	
LEDSC03-1-2HFB -		12	-	-	-	-	-	-	P.24
LEDL101 -		3	1.7	-	-	-	-	-	P.102
LEDL102 -		9	6	-	-	-	-	-	P.103
LEDL103 -		6	3/1.5	-	-	-	-	-	P.103
LEDL302 -		4.5	0.5	-	-	-	-	-	P.102
LEDTL101-CL -		12	27	-	-	-	-	-	P.80
LEDTL102-CL -		12	30	-	-	-	-	-	P.80
LEDWL101-SP -		12/24	8	-	-	-	-	-	P.86
LEDWL102-SP -		12/24	8	-	-	-	-	-	P.86
LEDWL103-WD -		12/24	8	-	-	-	-	-	P.86
ONYX L+7 -		12/24	0.5	-	-	0.5	20	-	P.106
ONYX M+7 -		12/24	0.5	-	-	0.5	20	-	P.106
ONYX-USB -		12/24	0.5	-	-	0.5	20	-	P.106
RBL101 -		24	70	-	-	-	-	-	P.104
RBL102 -		12/24	7	-	-	-	-	-	P.104

1) What do B3 and Tc mean in connection with the service life of bulbs? If we consider the service lives of products that are designed to last a certain time, we can see that they all have identical or similar failure characteristics. If we plot the service lives of the individual bulbs on special logarithmic graph paper, the graph produced is called a “Weibull distribution curve”. In a stable production process, we obtain a straight line for the service life via which we can read off various life values. For its products in the automotive sector, OSRAM specifies a B3 value, which indicates the time at which 3% of the tested bulbs have failed. OSRAM also specifies the Tc value (characteristic Weibull value), which indicates the time at which 63.2% of the bulbs have failed. Formerly, only the average value was specified (the average life), which in this system would correspond to a B50 value (i.e. the time at which 50% of the bulbs have failed). By specifying both the B3 value and the Tc value it is possible to get an idea of the spread of the product’s service life and hence the quality of the product.

Explanation: single filament lamp e.g. 100/300 | dual filament lamp e.g.  $\underbrace{100/300}_{B_3} / \underbrace{500/100}_{T_c}$

2) These products do not have ECE approval and must not be used on public roads in any exterior application. Public roads use leads to cancellation of operating license and loss of insurance coverage. Several countries forbid sale and use of these products. Please contact your local distributor for further information.

# Regional EAN overview

The new packaging reflects specific regional requirements by offering regionalized variants with a dedicated EAN.

■ Region 4 = LATAM ■ Region 5 = EMEA

COUNTRY	REGION LED + VAP Blister, DUO BOX	REGION ORIGINAL Blister	COUNTRY	REGION LED + VAP blister, DUO BOX	REGION ORIGINAL Blister	COUNTRY	REGION LED + VAP blister, DUO BOX	REGION ORIGINAL Blister	COUNTRY	REGION LED + VAP blister, DUO BOX	REGION ORIGINAL Blister
Albania		■	Denmark		■	Kosovo		■	Saint Lucia	■	
Algeria		■	Dominica	■		Kuwait		■	Saint Vincenta and the Grenadines	■	
Angola		■	Dominican Republic	■		Latvia		■	Saudi Arabia		■
Antigua and Barbuda	■		Grenada	■		Lebanon		■	Serbia		■
Argentina	■		Georgia		■	Libya		■	Slovakia		■
Armenia		■	Germany		■	Lithuania		■	Slovenia		■
Austria		■	Greece		■	Macedonia		■	South Africa		■
Azerbaijan		■	Guatemala	■		Morocco		■	Spain		■
Bahamas	■		Guyana	■		Mexico	■		Suriname	■	
Bahrain		■	Haiti	■		Moldavia		■	Sweden		■
Barbados	■		Honduras	■		Monte Negro		■	Switzerland		■
Belarus		■	Ecuador	■		Mosambique		■	Syria		■
Belize	■		El Salvador	■		Namibia		■	Tanzania		■
Benelux (Belgium, Netherlands, Luxembourg)		■	Egypt		■	Nicaragua	■		Trinidad and Tobago	■	
Bolivia	■		Estonia		■	Nigeria		■	Tunisia		■
Bosnia and Herzegovina		■	Ethiopia		■	Norway		■	Turkey		■
Botswana		■	Finland		■	Oman		■	UK/Ireland		■
Brazil	■		France		■	Pakistan		■	Ukraine		■
Bulgaria		■	Hungary		■	Palestine		■	United Arab Emirates		■
Chile	■		Iran		■	Panama		■	Uruguay	■	
Colombia	■		Iraq		■	Paraguay	■		Uzbekistan/ Turkmenistan		■
Costa Rica	■		Israel		■	Peru	■		Venezuela	■	
Croatia		■	Italy		■	Poland		■	Yemen		■
Czechia		■	Jamaica	■		Portugal		■	Zimbabwe		■
Cuba	■		Jordan		■	Qatar		■			
			Kazakhstan/ Kirgistan		■	Romania		■			
			Kenya		■	Russia		■			
						Saint Kitts and Nevis	■				

Product Reference

■ Region 4 = LATAM

■ Region 5 = EMEA

7506-02B	4052899402034	4050300925448
7507-02B	4052899531178	4050300925462
7225-02B	4052899402119	4050300925547
7528-02B	4052899402171	4050300925523
3893-02B	4052899407381	4050300647609
2821-02B	4052899418813	4050300925745
2825-02B	4052899418837	4050300925684
2827NA-02B	4052899570870	4052899570894
921-02B	4052899406933	4008321349507
7505-02B	4052899417878	4052899324565
7515-02B	4052899417892	4052899324589

---

<b>Product Reference</b>	<b>■ Region 4 = LATAM</b>	<b>■ Region 5 = EMEA</b>
2721-02B	4052899418790	4050300925769
2722-02B	4052899407251	4050300925783
5007-02B	4052899407015	4050300925585
5008-02B	4052899407176	4050300925608
6411-02B	4052899418936	4050300925646
64111-02B	-	4050300647258
6418-02B	4052899418950	4050300925622
6438-02B	-	4008321185389

# LEDDriving® lamps

## Overview of LED forward lighting applications



LEDDriving® SL – Exterior front lighting<sup>1)</sup>

1	2	3	4	5	6
Low beam / High beam	Daytime running light	Fog light	Front indicator	Parking/ marker light / Position light	Side indicator
≅ H1, H4, H7, H11, HB4	≅ H7, H8/H11/H16, PS13W, PS19W, P21W, P21/5W, P27/7W, W16W, W21W, W21/5W	≅ H8/H11/H16, H10	≅ P21W, P21/5W, PY21W, P27W, P27/7W, W21W	≅ P21/5W, P27/7W, W5W, W21W, W21/5W	≅ P21W, WY5W
P14.5s	PX26d	PGJ19	BA15s	BAY15d	BA15s
P43t	PGJ19	PY20d	BAY15d	W2.5x16q	W2.1x9.5d
PX26d	PG18.5d-1	PSX24W	BAU15s	W2.1x9.5d	
PGJ19-2	PG20-1		W2.5x16q	W3x16d	
P22d	BA15s		W3x16d	W3x16q	
	BAY15d				
	W2.5x16q				
	W2.1x9.5d				
	W3x16d				
	W3x16q				
Canbus Control Unit 50 W <sup>2)</sup>		Canbus Control Unit 21 W <sup>2)</sup>		Canbus Control Unit 5 W <sup>2)</sup>	

LED Color	Use behind red glass	Use behind clear glass	Use behind amber glass
<b>Red</b> (Tail light, Brake light)	Yes	Not recommended	Not recommended
<b>White</b> (Daytime running light, Reversing light, License plate light, Parking light)	Not recommended	Yes	Not recommended
<b>Amber</b> (Indicator light, Side marker light)	Not recommended	Yes	Yes



# LEDDriving® lamps

## Overview of LED rear lighting applications



LEDDriving® SL – Exterior rear lighting <sup>1)</sup>										
1	2	3	4	5	6	7				
Rear indicator	License plate light	Brake light, Third braking light	Rear fog light	Tail light	Reversing light	Additional brake light				
≅ P21W, PY21W, P27/7W, W21W	≅ C5W, R5W, R10W, T5/W2.3W, P21W, P21/5W, W5W	≅ P21W, P21/5W, P27/7W, W5W, W21W, W21/5W	≅ P21W, P21/5W, P27/7W, W16W, W21W	≅ P21W, P21/5W, P27/7W, R5W, R10W, T5/W2.3W, W5W, W21W, W21/5W	≅ P21W, P27/7W, W16W, W21W	≅ P21W, P21/5W, P27/7W, W5W, W21W, W21/5W				
BA15s	SV8.5-8 (31, 36, 41mm)	BA15s	BA15s	BA15s	BA15s	BA15s	BA15s	BA15s	BA15s	BA15s
BAU15s	BA15s	BAY15d	BAY15d	BAY15d	BAY15d	W2.5x16q	BAY15d	BAY15d	BAY15d	BAY15d
W2.5x16q	BA15s	W2.5x16q	W2.5x16q	W2.5x16q	W2.5x16q	W2.1x9.5d	W2.5x16q	W2.5x16q	W2.5x16q	W2.5x16q
W3x16d	W2x4.6d	W2.1x9.5d	W2.1x9.5d	W2.1x9.5d	BA15s	W3x16d	W2.1x9.5d	W2.1x9.5d	W2.1x9.5d	W2.1x9.5d
	BA15s	W3x16d	W3x16d	W3x16d	BA15s		W3x16d	W3x16d	W3x16d	W3x16d
	BAY15d	W3x16q			W2x4.6d		W3x16q	W3x16q	W3x16q	W3x16q
	W2.1x9.5d				W2.1x9.5d					
					W3x16d					
					W3x16q					
Canbus Control Unit 21W <sup>2)</sup>					Canbus Control Unit 5W and 21W <sup>2)</sup>					

Available color options:

LEDDriving® SL

Cool White
  Red

Amber

1) These products do not have ECE approval and must not be used on public roads in any exterior application. Public roads use leads to cancellation of operating license and loss of insurance coverage. Several countries forbid sale and use of these products. Please contact your local distributor for further information.

2) LEDDriving® CANBUS CONTROL UNIT (P.37) avoids error messages on the board computer when using LED lamps within 5 W, 21 W or 50 W applications

# LEDiving® Interior Lamps – Overview of LED interior lighting applications



INTERIOR APPLICATION



LEDiving® SL – Interior lighting <sup>1)</sup>									
1	2	3	4	5	6	7	8	9	10
Dome light front	Reading light front	Dome light behind	Reading light behind	Glovebox light	Trunk light	Legroom light	Door/Side light	Engine compartment light	Make-up mirror/visor light
≅ W5W, C5W, T4W, R5W, R10W, T5/W2.3W				≅ W5W, WY5W, C5W, T4W, R5W, R10W, T5/W2.3W		≅ W5W, WY5W, C5W, T4W, R5W, R10W, T5/W2.3W			≅ W5W, C5W, T4W, R5W, R10W, T5/W2.3W
W2.1x9.5d	W2.1x9.5d	W2.1x9.5d	W2.1x9.5d	W2.1x9.5d	W2.1x9.5d	W2.1x9.5d	W2.1x9.5d	W2.1x9.5d	W2.1x9.5d
SV8.5-8 (31, 36, 41mm)	SV8.5-8 (31, 36, 41mm)	SV8.5-8 (31, 36, 41mm)	SV8.5-8 (31, 36, 41mm)	SV8.5-8 (31, 36, 41mm)	SV8.5-8 (31, 36, 41mm)	SV8.5-8 (31, 36, 41mm)	SV8.5-8 (31, 36, 41mm)	SV8.5-8 (31, 36, 41mm)	SV8.5-8 (31, 36, 41mm)
BA9s	BA9s	BA9s	BA9s	BA9s	BA9s	BA9s	BA9s	BA9s	BA9s
BA15s	BA15s	BA15s	BA15s	BA15s	BA15s	BA15s	BA15s	BA15s	BA15s
BA15s	BA15s	BA15s	BA15s	BA15s	BA15s	BA15s	BA15s	BA15s	BA15s
W2x4.6d	W2x4.6d	W2x4.6d	W2x4.6d	W2x4.6d	W2x4.6d	W2x4.6d	W2x4.6d	W2x4.6d	W2x4.6d
Canbus Control Unit 5W 									

Available color options:  
LEDiving® SL

Cool White     Red  
 Amber

1) These products do not have ECE approval and must not be used on public roads in any exterior application. Public roads use leads to cancellation of operating license and loss of insurance coverage. Several countries forbid sale and use of these products. Please contact your local distributor for further information.

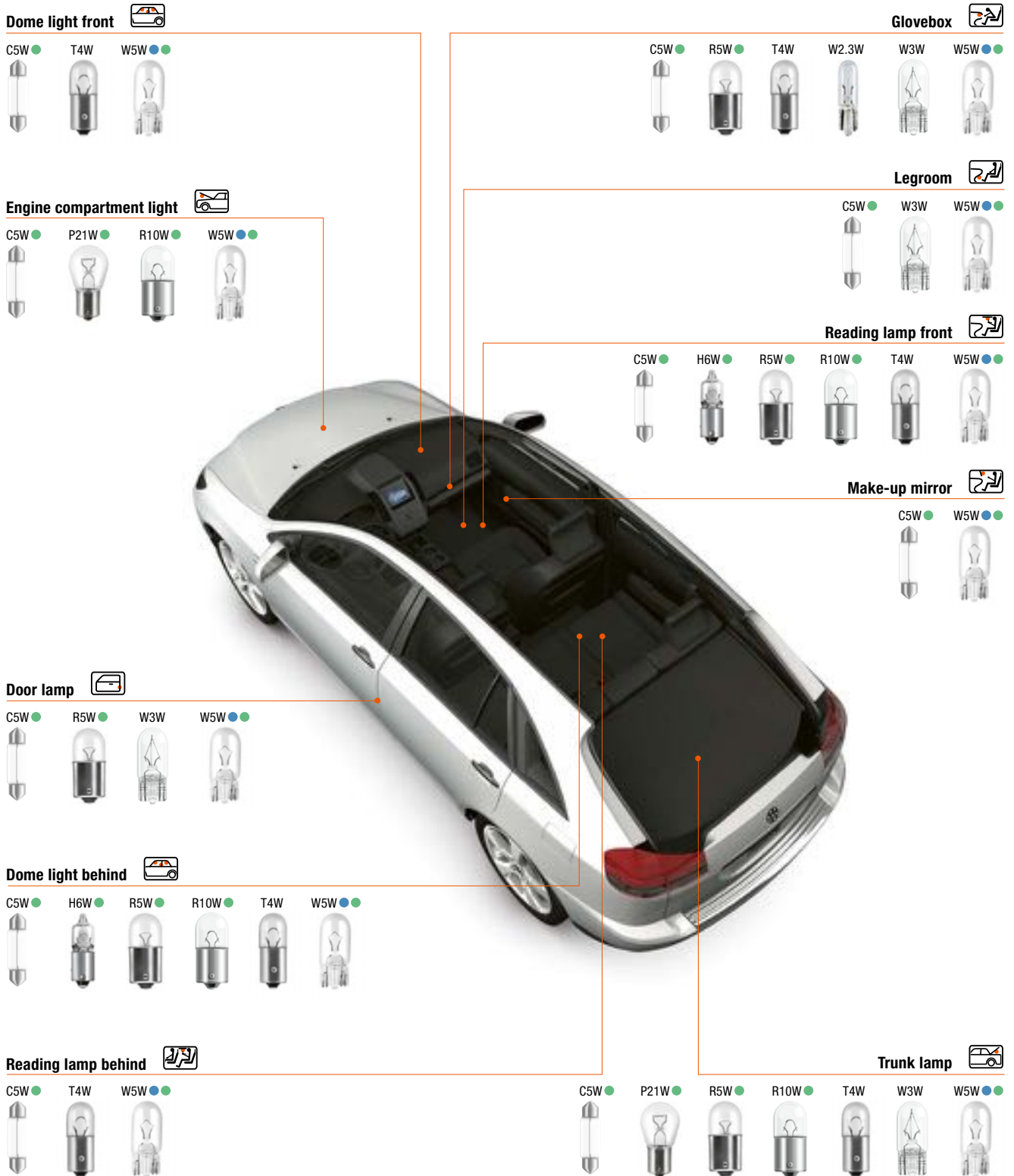

UPGRADE

**HALOGEN LIGHTING**

- **COOL BLUE® INTENSE (page 48)**
  - Extra white light for LED look
- **ULTRA LIFE (page 50)**
  - 4-year guarantee<sup>1)</sup>

1) 4th year with online product registration. Refer to [www.osram.com/am-guarantee](http://www.osram.com/am-guarantee) for precise conditions and registration

**Low beam / High beam**



**Fog light**



**Side indicator**

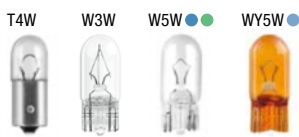

**Front indicator**



**Daytime running light**



**Parking/marker light**



UPGRADE

**HALOGEN LIGHTING**

- **NIGHT BREAKER® 200** (page 45)
  - Up to 200% more brightness<sup>1)</sup>
- **NIGHT BREAKER® LASER** (page 46)
  - Up to 150% more brightness<sup>1)</sup>
- **NIGHT BREAKER® SILVER** (page 47)
  - Up to 100% more brightness<sup>1)</sup>

- **COOL BLUE® INTENSE** (page 48)
  - Extra white light for LED look
- **DIADEM® CHROME** (page 49)
  - Only amber when ON
- **ULTRA LIFE** (page 50)
  - 4-year guarantee<sup>2)</sup>

**Brake light / Third braking light**  



**Rear indicator** 



**Tail light** 



**License plate light** 



**Rear fog light** 



**Reversing light** 



**XENON LIGHTING**

- **XENARC® NIGHT BREAKER® LASER (page 39)**
  - Up to 200% more brightness<sup>3)</sup>
- **XENARC® COOL BLUE® INTENSE (page 40)**
  - Extra white light for LED look
- **XENARC® ULTRA LIFE (page 41)**
  - 10-year guarantee<sup>4)</sup>

1) Compared to minimum ECE R112/R37 requirements  
 2) 4th year with online product registration. Refer to [www.osram.com/am-guarantee](http://www.osram.com/am-guarantee) for precise conditions and registration  
 3) Compared to minimum ECE R98/R99 requirements  
 4) With online product registration. Refer to [www.osram.com/am-guarantee](http://www.osram.com/am-guarantee) for precise conditions and registration



**Parking/marker light** 



**Side indicator** 



**Front indicator** 



**Side-marker light** 



**License plate light** 



**Low beam / High beam**  

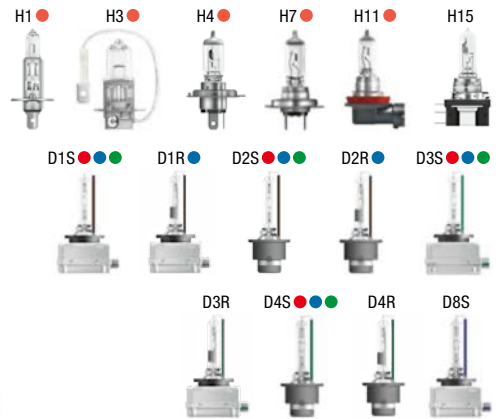

**Daytime running light** 



**Fog light** 

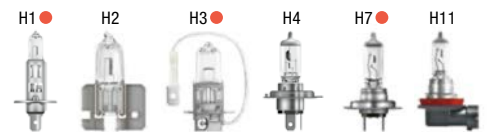

**Parking/marker light** 



**Indicator/brake/rear fog/tail and reversing light**



UPGRADE

**HALOGEN LIGHTING**

- **TRUCKSTAR® PRO** (page 57)
- Up to 2.5x more lifetime<sup>1)</sup>

1) Compared with standard lamps  
 2) Compared to minimum ECE R98/R99 requirements  
 3) With online product registration. Refer to [www.osram.com/am-guarantee](http://www.osram.com/am-guarantee) for precise conditions and registration

**XENON LIGHTING**

- **XENARC® NIGHT BREAKER® LASER** (page 39)
- Up to 200% more brightness<sup>2)</sup>
- **XENARC® COOL BLUE® INTENSE** (page 40)
- Extra white light for LED look
- **XENARC® ULTRA LIFE** (page 41)
- 10-year guarantee<sup>3)</sup>

**Low beam / High beam / Fog light**

H1 ● H3 ● H4 ● H7 ● H8 ● H11 ● HS1 ● HB3 ●

HB4 ● HIR2 ● S1 ● S2 ● R2 ●

D1S ● D1R ● D2S ●

**Front indicator / parking/marker light**

H6W ● H21W ● P21W ● P21/5W ● PY21W ●

R5W ● R10W ● RY10W ● T4W ●

W3W ● W5W ● WY5W ● W16W ●

W21W ● W21/5W ● WY21W ●

**License plate light**

C5W ● H6W ● P21W ● P21/5W ● R5W ● R10W ● T4W ● W3W ● W5W ●

**Reversing/brake/rear fog light**

P21W ● P21/5W ● P27/7W ●

R5W ●

R10W ● T4W ● W5W ●

WY5W ● W16W ● W21/5W ●

**Rear indicator**

H6W ● P21W ● P21/5W ●

PY21W ● R10W ● RY10W ●

W5W ● WY5W ● W16W ●

WY16W ● W21W ● WY21W ●

**HALOGEN LIGHTING**

- **NIGHT BREAKER® 200 (page 45)**
  - Up to 200% more brightness<sup>1)</sup>
- **NIGHT BREAKER® LASER (page 46)**
  - Up to 150% more brightness<sup>1)</sup>
- **NIGHT BREAKER® SILVER (page 47)**
  - Up to 100% more brightness<sup>1)</sup>
- **COOL BLUE® INTENSE (page 48)**
  - Extra white light for LED look
- **DIADEM® CHROME (page 49)**
  - Only amber when ON
- **ULTRA LIFE (page 50)**
  - 4-year guarantee<sup>2)</sup>

1) Compared to minimum ECE R112/R37 requirements  
 2) 4th year with online product registration. Refer to [www.osram.com/am-guarantee](http://www.osram.com/am-guarantee) for precise conditions and registration

### Base stamp

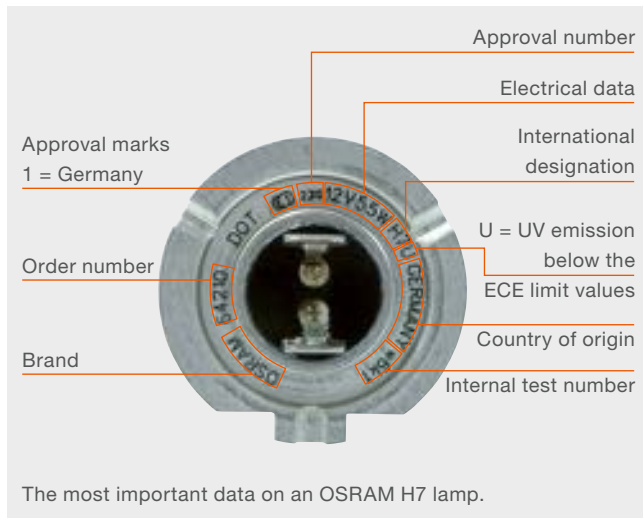

### Notes on product labeling

	Not for residential lighting		Do not dispose with household waste
	High levels of UV radiation		Switch off lights before replacing lamp
	Installation and maintenance only by qualified electricians		Ignition procedure for lamps with external igniter
	Caution: Hot		Lamp cannot be dimmed
	Hazardous voltage		Wear suitable gloves when fitting or removing
	Do not use the lamp if the glass bulb is scratched or damaged		Protect against splashes
	Wear suitable goggles when fitting or removing		Operate only in shielded luminaires
	Do not touch the glass bulb; hold the base when inserting		Pb-free

### Lamps per Product number



Any manipulation of our products or packaging, including but not limited to modification, reworking or restamping, is prohibited and infringes our registered trademark rights. Such modifications may impair the technical properties of our products, destroy them or cause consequential damage or injury, for which OSRAM cannot under any circumstances be held responsible. For more information on our products, go to: [www.osram.com](http://www.osram.com)

## Glossary of the most important lighting terms

### Luminous flux $\Phi$

Unit of measurement: lumen [lm]

Luminous flux  $\Phi$  is the total radiated power emitted by a light source evaluated with the spectral sensitivity of the eye and the photometric radiation equivalent  $K_m$ .

Luminous flux  $\Phi$  is the luminous intensity  $I$  emitted in the entire solid angle  $\Omega$ .

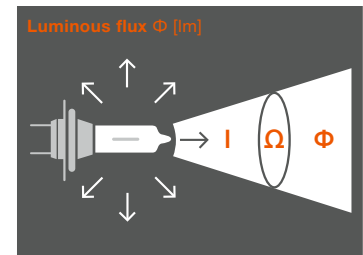

### Luminous intensity I

Unit of measurement: candela [cd]

Generally speaking, a light source emits its luminous flux  $\Phi$  in different directions and at different intensities.

Luminous intensity is the luminous flux radiated in a specific direction (solid angle  $\Omega$ ).

Polar diagram.

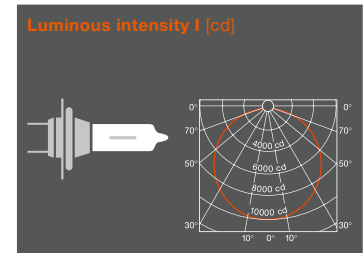

### Illuminance E

Unit of measurement: lux [lx]

Illuminance  $E$  is the ratio between the luminous flux and the area illuminated. An illuminance of 1 lx occurs when a luminous flux of 1 lm is evenly distributed over an area of 1 m<sup>2</sup>.

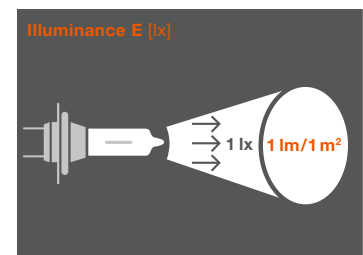

### Luminance L

Unit of measurement: candela per square meter [cd/m<sup>2</sup>]

The luminance  $L$  of a light source or an illuminated area is a measure of the impression of brightness.

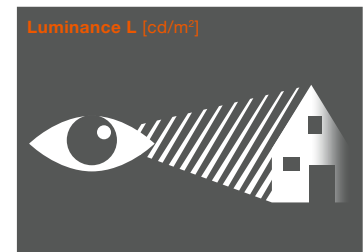

### Luminous efficacy $\eta$

Unit of measurement: lumens per watt [lm/W]

Luminous efficacy  $\eta$  indicates the efficiency with which the electrical power consumed is converted into light.

### Color temperature

Unit of measurement: Kelvin [K]









The color temperature of a light source is defined in comparison with a "black body radiator" and plotted on what is known as the "Planckian curve." The higher the temperature of this black body radiator is, the greater the blue component in the spectrum and the smaller the red component.

### Lamp life

The  $B_3$  life-span value represents the premature failure rate of lamps. This means that 3% of all tested lamps will have failed after this number of burning hours.

The  $T_c$  lifespan value represents the failure rate of 63.2% of the lamps.

## Symbols

<b>ECE</b>	Int. category label ECE
<b>W</b>	Rated wattage in watts
<b>W<sub>In</sub></b>	Power consumption in watts
<b>V</b>	Voltage in volts
<b>V<sub>Test</sub></b>	Test voltage in volts
<b>Im</b>	Luminous flux in lumens
<b>T[h] B3/Tc</b>	Lifespan (h)
<b>Ix</b>	Illuminance in lux
<b>λ [nm]</b>	Wavelength (λ)
<b>K</b>	Color temperature in K
 <b>COLOR</b>	Light color
<b>i</b>	Information
	Base
 <b>No.</b>	Fig. no.
<b>KIT</b>	Set
 <b>w [mm]</b>	Width b in mm
 <b>h [mm]</b>	Height h in mm
 <b>l [mm]</b>	Length l in mm
	Shipping unit
	Single packaging

## Packaging variants

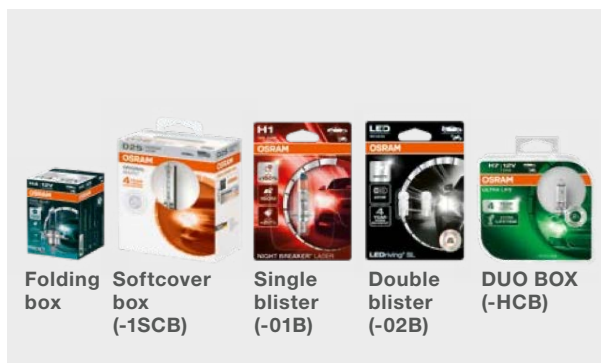



**Stay up to date!**

**Follow OSRAM Automotive on Facebook:**

[www.facebook.com/osramautomotive](http://www.facebook.com/osramautomotive)

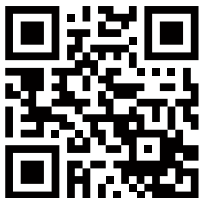

**Get inspired and take your car to the next level! Follow us on Instagram:**

[www.instagram.com/osram.automotive](http://www.instagram.com/osram.automotive)



**Installation tutorials, product videos and more! Follow our YouTube channel:**

[www.youtube.com/OSRAMAutomotive](http://www.youtube.com/OSRAMAutomotive)



OSRAM is the world market leader in automotive lighting. Our customers include the world's foremost automobile manufacturers. Half of all passenger vehicles manufactured globally each year are equipped with OSRAM lights.

#### OSRAM SITES

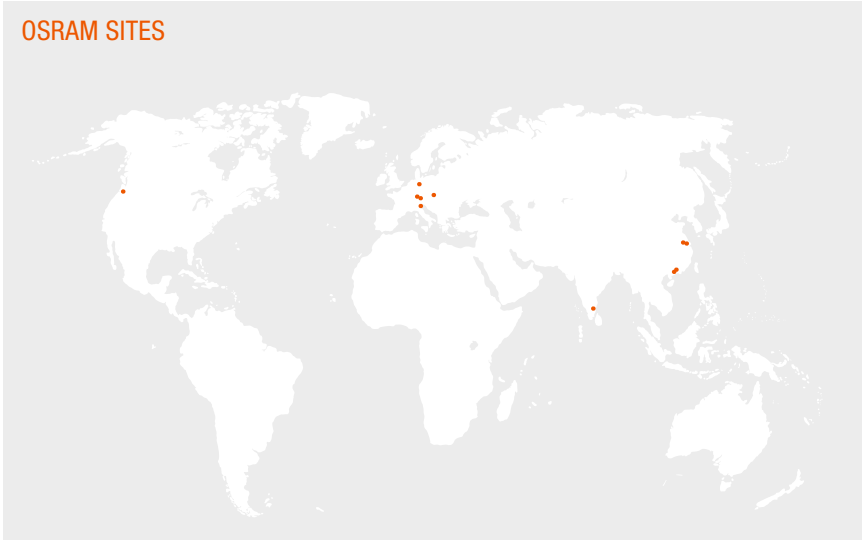

#### Light range 2022 – always up-to-date

Download the pdf of our current catalog that's constantly updated. [www.osram.com/am-catalog-digital](http://www.osram.com/am-catalog-digital)

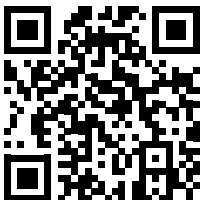

#### Which lamps fit your vehicle?

Find out with our **Vehicle Lamp Finder** online app:

[www.osram.com/vehicelamps](http://www.osram.com/vehicelamps)



#### OSRAM GmbH

Head office:

Marcel-Breuer-Strasse 6  
80807 Munich, Germany  
Phone +49 89 6213-0  
Fax +49 89 6213-2020  
[www.osram.com](http://www.osram.com)

# OSRAM